

W

WELLNESS

SAUNAVITA®
 calore naturale

HAFRO®
acqua, per piacere

WELLNESS

**L'emozione
della SPA a casa tua**

***Bring the SPA to
your home***



“Lavoriamo con quella speciale creatività che nasce dalla collaborazione, dal sentirsi tutti parte di un grande equipaggio in navigazione verso l'emozione di un nuovo prodotto, una nuova linea, un nuovo design. E' questo lo spirito che anima il nostro Gruppo, e che ogni giorno ci fa trovare il piacere delle cose fatte a regola d'arte.”



“Our work uses the special creativity that emerges from collaboration, from everyone feeling like part of a big team focused on the excitement of a new product, new line or new design. This is the spirit that animates our Group, and that brings us the pleasure of well-made products, each and every day.”

MADE IN ITALY QUALITY

UNA STORIA FATTA DI VALORI

A story made of values

Fiducia, visione, eccellenza, dinamismo: sono questi i valori che hanno ispirato il Gruppo Geromin durante tutta la sua lunga storia. Fiducia dell'utilizzatore finale nei nostri prodotti, di cui assicuriamo la totale affidabilità. Una visione che coniuga la cultura del Made in Italy con una continua attività di ricerca e innovazione ispirata ai trend estetici e tecnologici internazionali. L'eccellenza come caratteristica chiave di un prodotto che garantisce massima qualità, lunga durata e ridotta manutenzione. Dinamismo a tutti i livelli: dalla progettazione e realizzazione dei prodotti, alla loro comunicazione, basata sull'impegno quotidiano del nostro ufficio marketing, sempre attento e aggiornato sulle tecniche e i sistemi più innovativi. Tutto questo alimenta la passione che ci consente di ottenere il meglio a livello di design, sicurezza e funzionalità per raggiungere la totale soddisfazione del cliente, requisito che consideriamo una responsabilità imprescindibile e un grande privilegio.

Trust, vision, excellence, dynamism. These are the values that have inspired Geromin Group throughout its entire history. The trust end users place in our products, because they know how reliable they are. A vision that combines the culture of Italian quality and continuous research and innovation inspired by international aesthetic and technological trends. Excellence as the key feature of a product of the highest quality, durability, and lowest maintenance. Dynamism at all levels, be it in the design and manufacturing of our products or their communication based on the latest and most innovative techniques and systems. All this has fuelled the passion that has allowed us to achieve the best in terms of design, safety, and functionality and ensure customer satisfaction, which we consider our responsibility as well as a privilege.



“Da oltre 70 anni, Gruppo Geromin impiega materiali di pregio e tecnologie all'avanguardia per progettare e realizzare ambienti wellness e arredo bagno di qualità.”

“Geromin Group has been using fine materials and advanced technology for over 70 years to design and create wellness settings and high-quality bathroom furniture.”



VENEZIA 1945

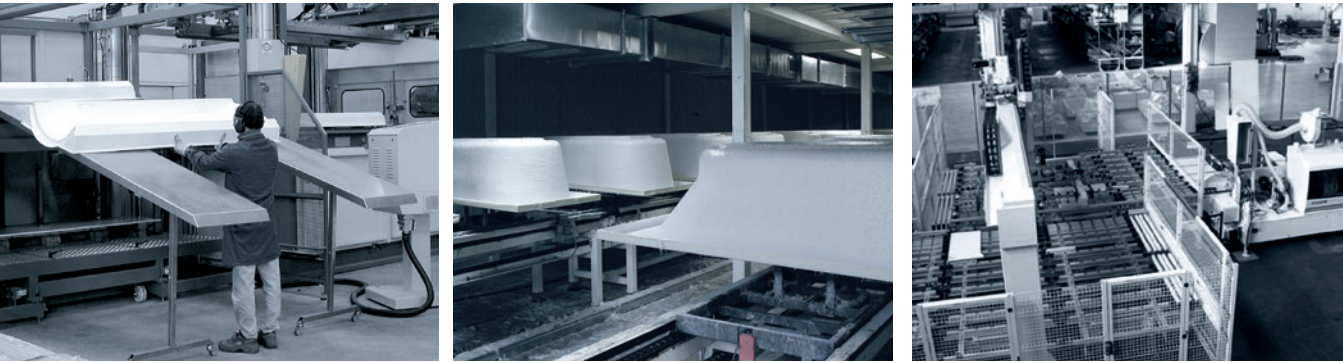

UN PROCESSO INDUSTRIALE SOLIDO ED EFFICACE

A solid and effective industrial process

Le aree operative del Gruppo Geromin si estendono su 20.000 mq, nei quali l'attenzione artigianale che da sempre ci contraddistingue, convive con sistemi produttivi e logistici all'avanguardia e a basso impatto ambientale. In questo modo garantiamo massima qualità ed efficienza a partire dalla produzione fino alla consegna. Dalla linea produttiva ai magazzini, l'utilizzo di macchinari tecnologicamente avanzati e il rispetto di elevati standard di efficienza consente la massima precisione nella realizzazione di prodotti di alta qualità e nella loro spedizione.

Geromin Group's production sites cover 20,000 sq.m, where craftsmanship goes hand in hand with state-of-the-art and low-impact production and logistics systems.

This way, we can guarantee the highest quality and efficiency, from production to delivery. Cutting-edge machinery, both in the production lines and the warehouses, and compliance with the highest efficiency standards allow for maximum precision in the manufacturing high-quality products and their shipment.

UNA RETE DISTRIBUTIVA ESTESA E CONSOLIDATA

A widespread and consolidated network

Grazie ad un impegno costante e a continui investimenti nelle strategie commerciali, nella rete distributiva e in una puntuale assistenza al consumatore, il Gruppo ha consolidato la presenza dei propri prodotti nei mercati di tutto il mondo.

Thanks to a constant commitment and continuous investments in commercial strategies, in the distribution network and in a timely assistance to the consumer, the Group has strengthened the presence of its products in markets all over the world.

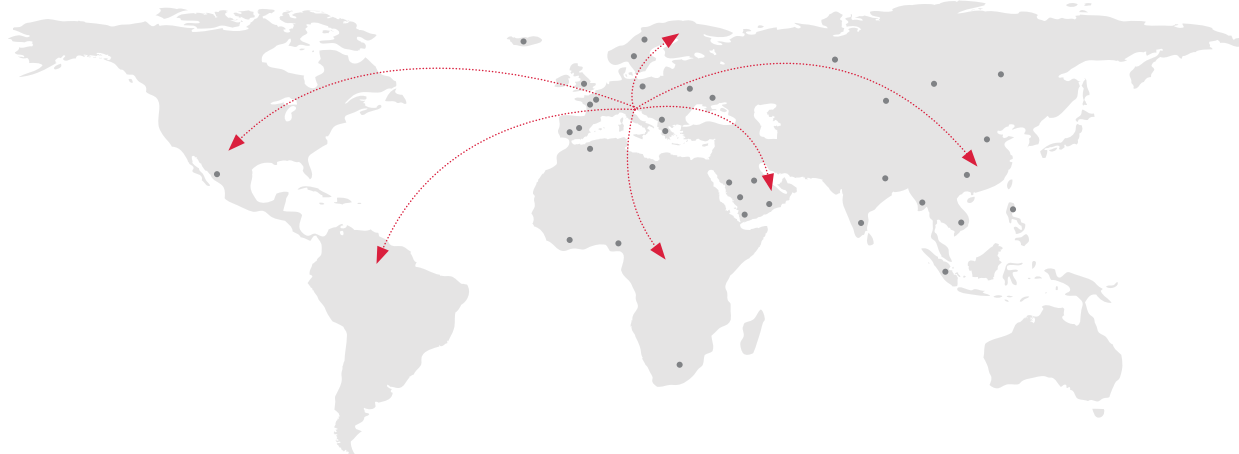

GEROMIN



3 BRAND PER UN UNICO GRANDE GRUPPO

3 brands for one great group

Wellness & Shower

Hafro parte dall'idea dell'acqua come elemento fondamentale della cura del corpo per realizzare vasche idromassaggio, minipiscine, hammam, generatori di vapore, box doccia multifunzione e sistemi doccia completi.

Hafro's whirlpool baths, mini-pools, Turkish baths, steam generators, multifunction shower cubicles, and complete shower systems result from our belief that water as an essential element for body care.



Bathroom & Laundry

Geromin è il marchio che interpreta l'arredo bagno e la lavanderia con soluzioni pratiche e materiali di qualità, dando vita a linee di prodotti versatili che rendono gli ambienti di servizio della casa sempre più funzionali.

Geromin interprets bathroom and laundry furniture with practical solutions and quality materials, resulting in a versatile range of products that adds increased functionality to every utility room.



Heat & Health

Attraverso la sapiente mescolanza di legni pregiati e finiture speciali, Saunavita crea saune e hammam dalle eccellenti prestazioni, nel rispetto dell'antica tradizione del benessere legata alla Sauna Finlandese e al Bagno Turco.

Saunavita creates high-performance saunas and Turkish baths by skilfully combining different types of fine wood and special finishes, in line with the long-standing tradition of Finnish saunas and Turkish baths.



WELLNESS

*indice collezioni
collection index*

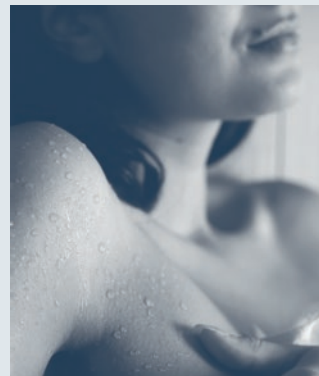

page 021

**Saune e hammam /
Saune**
*Saunas and hammam /
Saunas*

page 148

Soffione emozionale
Multi-sensory shower head

page 152

Doccia scozzese
Bucket shower



page 157

Hammam
Ghibli
Sv Steam

SAUNAVITA®
calore naturale



page 193

Hammam
Linea Rigenera
G-Steam
Gemini

HAFRO®
acqua, per piacere

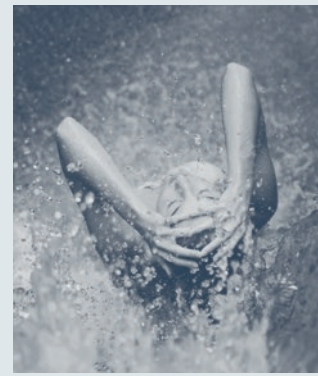

page 245

**Box doccia
multifunzione**
*Multifunction
shower cubicles*

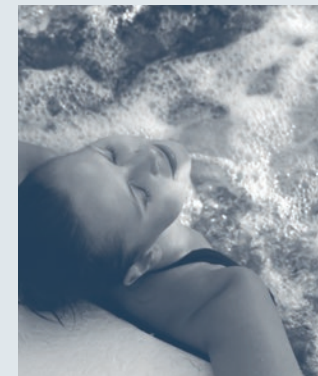

page 275

Vasche idromassaggio
Hydromassage tubs



page 389

Vasche combinate
*Washtubs with crystal
glass shower cabin*



page 398

Soprasvasca Time
Time bath screen

page 400

**Rubinetteria
Finiture / Tastiere**
*Taps / Finishes
Controls*

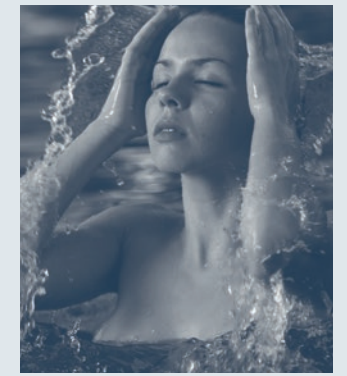

page 409

Vasche ad incasso
Built-in bathtubs

SAUNA

Dalla Finlandia la cultura del calore secco
The culture of dry heat straight from Finland

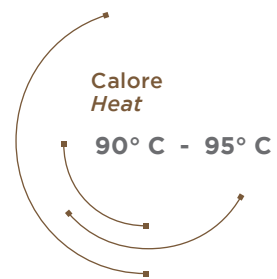

HAMMAM

Una nuvola di vapore e di benessere
Clouds of steam and wellness

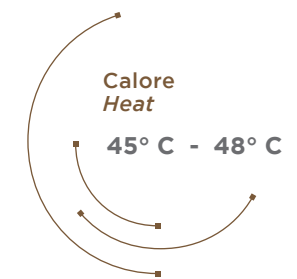

ISPIRARSI ALLA NATURA

Inspired to nature

La natura racchiude in sé tutti gli elementi necessari a ristabilire l'equilibrio tra corpo e mente, equilibrio che troppo spesso perdiamo per rimanere al passo con i ritmi frenetici della vita moderna. Per questo, sempre più persone cercano modi e momenti per creare un dialogo con la natura. Dal legno, dall'aria, dall'acqua e dal fuoco derivano effetti benefici e risanatori che fin dai tempi antichi l'uomo ha imparato a sfruttare a proprio favore. La nostra ricerca nel mondo delle saune è innanzitutto un ritorno alla natura attraverso la scelta dei legni più pregiati, per presentare la forma più evoluta di un antico rituale di benessere. Le nostre saune rappresentano un modo per entrare in contatto con gli elementi attraverso i principi salutarî racchiusi in essi. Abbandonandosi al caldo abbraccio di questa pratica millenaria si riscoprono sensazioni da tempo dimenticate, come il profumo del legno e le sue vibrazioni naturali, sprigionate dalle elevate temperature del calore secco, capaci di nutrire il corpo e lo spirito, restituendoci armonia e serenità.

Nature holds all the elements to restore the balance between body and mind. A balance that we often lose when we attempt to keep up with the hectic pace of day-to-day life. That's why an increasing number of people are looking for ways and moments to connect with nature. Humans have been using the beneficial effects of wood, air, water, and fire since the dawn of times. Our research in the world of sauna is, first of all, a return to nature through the selection of the finest wood to achieve the most advanced form of an ancient ritual. Our saunas are a wonderful way to connect with the elements and their beneficial principles. The warm embrace of this ancient ritual will make you rediscover long-forgotten sensations, such as the scent of wood and the natural vibrations released by dry heat. Vibrations that nourish body and soul, restoring harmony and serenity.



UN RITUALE ANTICO MA ATTUALE

An ancient yet modern ritual



Le origini della sauna risalgono al XII secolo, in Finlandia, dove le temperature rigide la rendevano una vera e propria necessità. Già allora erano noti i benefici apportati dall'aria calda e secca sulla salute di corpo e mente, tanto che a questi ambienti veniva attribuito un valore sacro. Dall'antichità, la pratica della sauna è arrivata fino ad oggi, evolvendosi nelle tecnologie e nei materiali, ma rimanendo un efficace rituale di benessere.

The history of sauna dates back to the 12th century in Finland, where the cold temperatures made it a necessity. The beneficial effects of hot, dry air on body and mind were already known back then. In fact, these settings were somewhat sacred. Today, the sauna has evolved in terms of technology and materials, but it has always remained faithful to its nature of a wellness ritual.



mali di stagione
seasonal illnesses

aumenta il metabolismo
boost your metabolism

articolazioni
joints benefits

espulsione di tossine
toxins expulsion

pulizia della pelle
skin cleaning

circolazione
blood flowing

BENEFICI PER TUTTO IL CORPO

Benefits for all the body

Grazie alle alte temperature e al basso tasso di umidità, la sauna stimola la circolazione e attiva la sudorazione, con effetti benefici sulla salute dell'intero organismo.

The high temperatures and low humidity rates of a sauna stimulate blood circulation and transpiration, with beneficial effects on the whole body.

PROGETTI SPA SU MISURA

Spa tailor-made projects

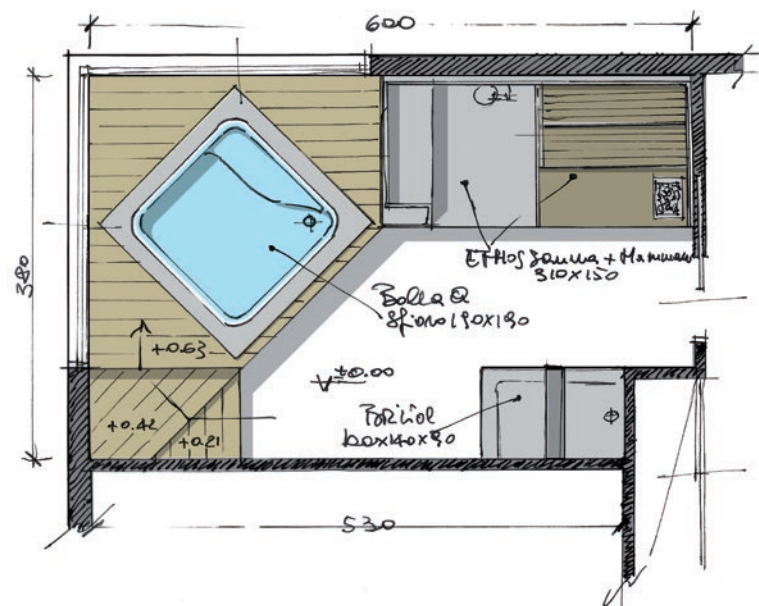

Ogni momento di benessere è unico grazie a soluzioni su misura e personalizzazioni speciali. Sauna Vita crea ambienti wellness completi con sistemi progettati appositamente per qualsiasi tipo di spazio ed esigenza.

We provide tailor-made solutions to let you enjoy every single moment of wellness. Sauna Vita creates wellness environments complete with systems designed specifically for any type of setting and requirement.

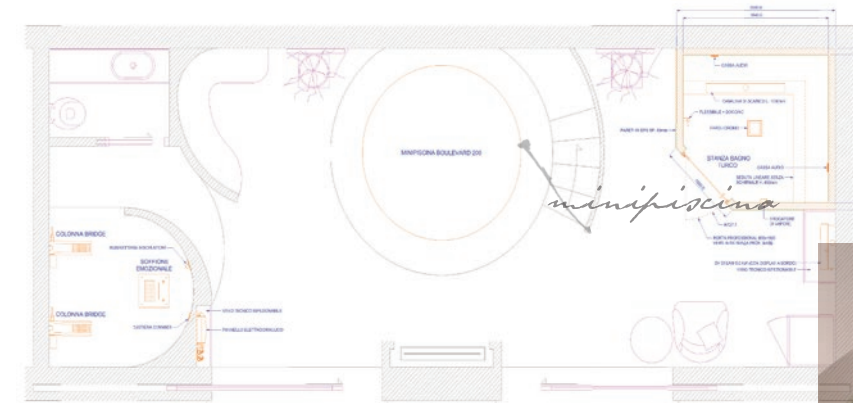

MASSIMA PERSONALIZZAZIONE PER SPAZI PROFESSIONALI

Veri e propri progetti di interior design dedicati agli ambienti professionali: l'alta qualità dei materiali, design esclusivi e tecnologie all'avanguardia diventano un tutt'uno e danno forma a spazi wellness personalizzati in ogni misura e dettaglio.

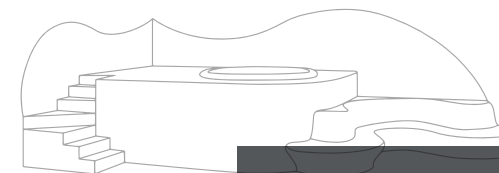
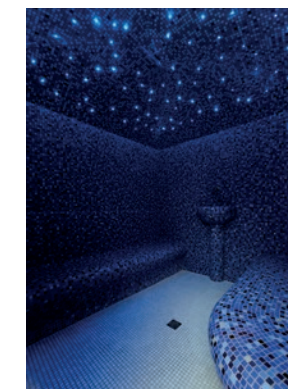

Extreme customisation for professional settings

True interior design projects for professional settings. High-quality materials, exclusive design, and state-of-the-art technologies merge together to create customised wellness settings.

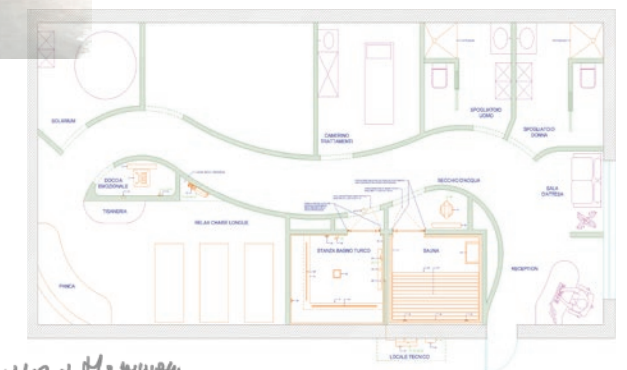

Sauna + Hammam

PIÙ FUNZIONALITÀ AL BENESSERE

When wellness becomes functional



ACCESSORI E COMPLEMENTI *Accessories and complements*

Dall'esclusiva chaise longue alla panca e al tavolino in legno e fuselli in faggio con struttura in acciaio inox o verniciato, dai comodi poggiaschiena e poggiatesta agli accessori per la gestione della sauna, ogni elemento è progettato per darti il massimo del comfort.

Exclusive chaise longues, wooden benches and tables, beech spindles with a stainless steel structure, comfortable backrests and headrests, and sauna-management accessories. Every element is designed to ensure the utmost comfort.

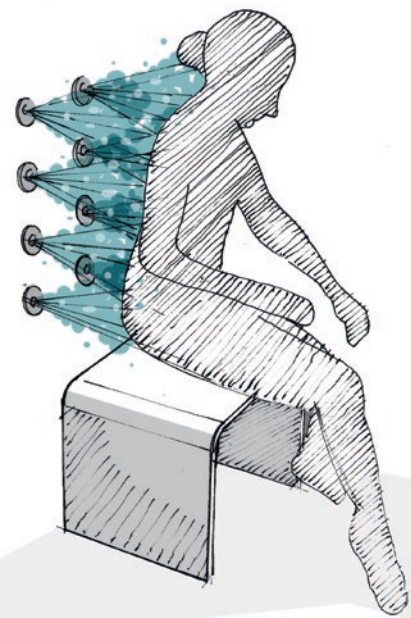

Una ricca collezione di accessori e complementi rende ancora più funzionale - e personale - il bagno turco e la sauna. Finiture coordinate, design ergonomici e oggetti utili arredano lo spazio e danno ancora più valore al benessere.

A rich collection of accessories to make Turkish baths and saunas an even more functional and personal experience. Matching finishes, ergonomic design, and useful items furnish the space, enhancing the value of wellness.



SAUNE E HAMMAM

SAUNAS AND TURKISH BATH

Olimpo sauna + hammam **030**

Ethos sauna + hammam **048**

Ethos C | Ethos L sauna + hammam **066**

Ghibli sauna sauna **082**

Kalika sauna **090**

Cuna doccia sauna + doccia **108**

Cuna sauna **116**

Talia sauna **124**

Kyra sauna **130**

Outdoor sauna **144**

Soffione emozionale **148**
Multi-sensory shower head

Doccia scozzese **152**
Bucket shower

RISPETTO PER L'AMBIENTE

Environmentally-friendly

Il rispetto per la natura è da sempre una nostra priorità. Per questo ogni ambiente wellness è realizzato adottando processi produttivi etici e sfruttando legnami provenienti da piantagioni ecologiche.

We love and respect nature. That's our priority. Every wellness space is created using ethical production processes and wood from sustainable crops.

SAUNAVITA®
calore naturale

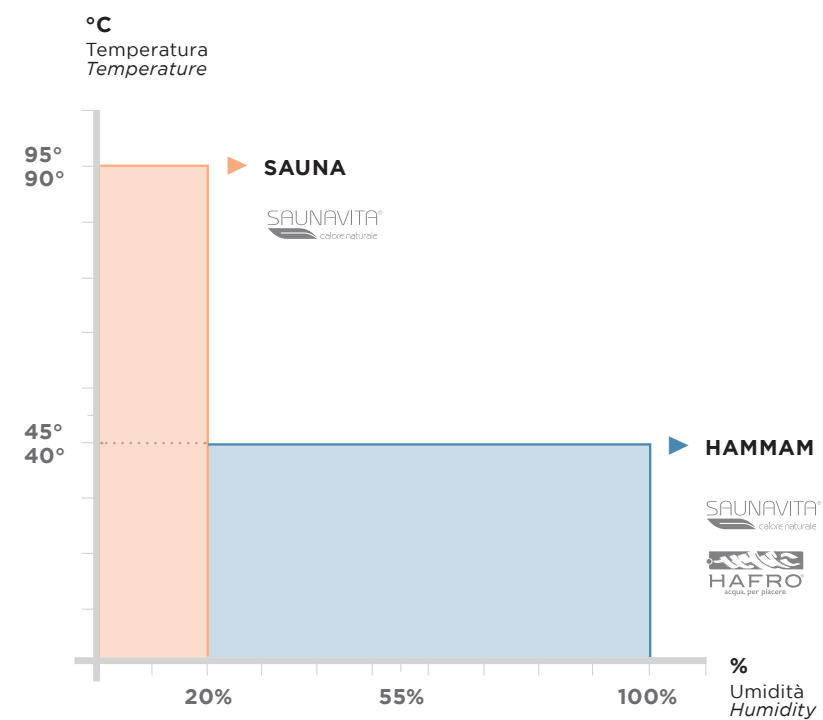

RAPPORTO TEMPERATURA - UMIDITÀ Temperature-humidity ratio

Nelle saune e hammam ci ispiriamo alla natura per ricreare dei microclimi con il giusto rapporto tra temperatura e umidità, in modo da trasmettere tutta l'armonia degli ambienti wellness.

Our saunas and Turkish baths are inspired by nature to recreate microclimates with the perfect temperature-humidity ratio, so as to provide the same harmony as wellness settings do.

ACCESSORI E OPTIONAL

Accessories and optional



MASTELLO E MESTOLO

Due accessori indispensabili nelle saune tradizionali. L'acqua contenuta nel mastello viene versata sulle pietre per la vaporizzazione.

Bucket and ladle

Two must-have accessories in traditional saunas. The water contained in the bucket is poured onto stones, and evaporates.



TERMOIGROMETRO

Installato all'interno della sauna, il termoigrometro è uno strumento che permette di controllare la temperatura e l'umidità.

Thermo-hygrograph

The thermo-hygrograph is installed inside the sauna and controls both temperature and humidity.



CLESSIDRA

La clessidra segna tempo è lo strumento fondamentale per misurare la permanenza all'interno dell'ambiente sauna.

Hourglass

The hourglass is essential to measure your stay inside the sauna.



POGGIASCHIENA

Un pratico ed ergonomico supporto per il corpo che arreda la sauna e costituisce un comodo appoggio.

Backrest

A practical and ergonomic support for your body and a wonderful piece of furniture for your sauna.



PANCA CON LUCE LED

Un sottile fascio di luce lungo il lato della panca contribuisce a creare un'atmosfera rilassante nella sauna.

Bench fitted with a led light

A thin light beam along the side of the bench creates a relaxing atmosphere in the sauna.



LAMPADA INTERNA

La lampada interna alla sauna è un accessorio decorativo e diffonde la luce con un particolare effetto raggiato.

Internal lamp

The sauna's internal lamp is not just a decoration, but it also creates a unique ray effect.

TEMPERATURE NELLA SAUNA

Temperatures In the sauna

All'interno dell'ambiente sauna il costante ricircolo d'aria fresca determina diversi livelli di calore: il punto più caldo è all'altezza del soffitto, mentre vicino al pavimento la temperatura è simile a quella esterna.

The constant recirculation of fresh air inside the sauna generates different heat levels. The ceiling is the hottest point, whereas the temperature near the flooring is similar to the exterior one.

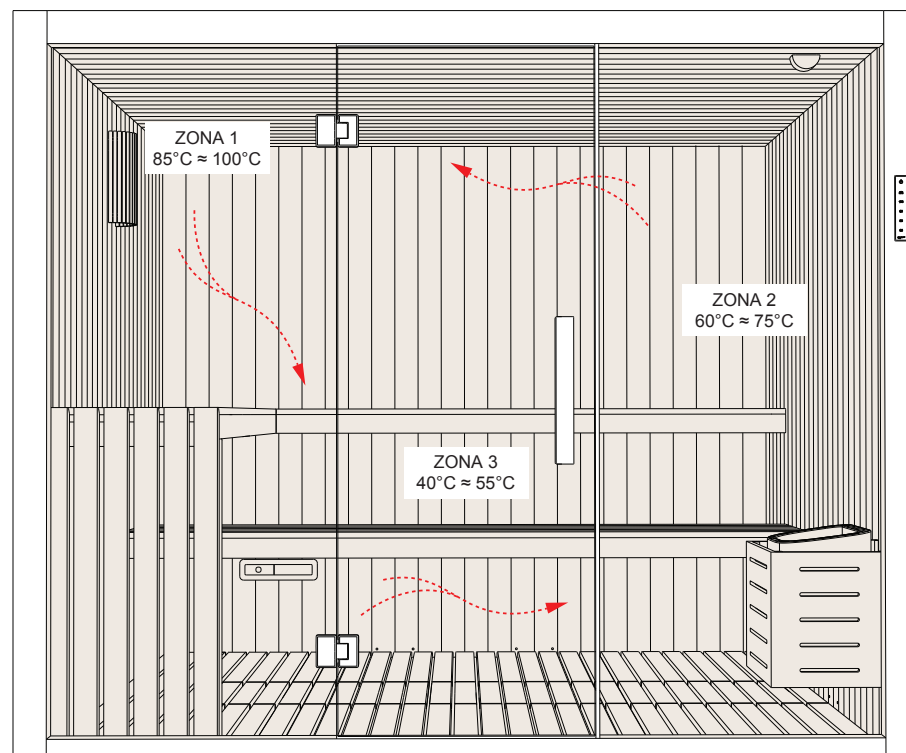

LA QUALITÀ SUPERIORE DI UN PRODOTTO SAUNA VITA

The superior quality of a Sauna Vita product

La coibentazione delle pareti perimetrali e del soffitto della sauna viene realizzata con lana di roccia e legno naturale per evitare la dispersione del calore. Il sistema di montaggio è facile e veloce: ogni singolo componente è già stato collaudato precedentemente in azienda e tutti i pezzi si incastrano in modo veloce ed univoco tra loro per garantire un montaggio a regola d'arte.

The sauna's perimeter walls and ceiling are insulated with rockwool and natural wood to prevent heat dissipation. The assembly system is quick and easy: every single component has already been tested beforehand in the factory and all the pieces fit together quickly and unequivocally to ensure a perfect assembly.

Lana di roccia
Rock wool



Legno naturale
Natural wood



L'IMPORTANZA DEL LEGNO

The importance of wood

La tradizione vuole che le saune siano costruite in legno.

Un materiale versatile e ricco di proprietà benefiche, che continua a vivere anche dopo l'abbattimento della pianta, perfetto per conservare e propagare il calore. Un'attenta ricerca tra le molte varietà disponibili e la lunga esperienza nel settore, ci hanno portato a selezionare per le nostre saune i legnami migliori, resistenti alle alte temperature e caratterizzati da profumi avvolgenti e rilassanti. Oltre agli aromi naturali, il legno propaga vibrazioni sonore che entrano in contatto con le vibrazioni naturali del corpo, creando un'atmosfera armonica di puro piacere.

According to tradition, a sauna should be made of wood. A versatile material with multiple beneficial effects that continue even after a tree has been felled. Perfect for storing and propagating heat. Our research and experience have led us to select the best, most fragrant timber for saunas to ensure relaxing and enveloping moments. In addition to its natural aromas, wood propagates sound vibrations that come into contact with the body's natural vibrations, thereby creating a harmonious atmosphere of pure pleasure.

FINITURE

Finishes

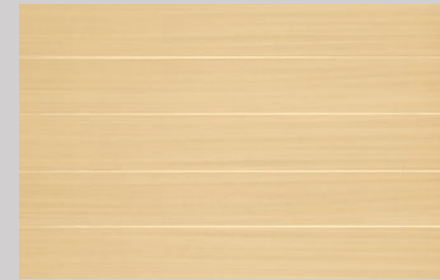

Abachi

Un legno molto resistente agli sbalzi di temperatura e a zero trasmissibilità termica.
A wood extremely resistant against temperature changes and with zero thermal conductivity.



Abete

Un legno profumato per creare ambienti estremamente naturali e rilassanti.
A scented wood is used to create natural and extremely relaxing settings.

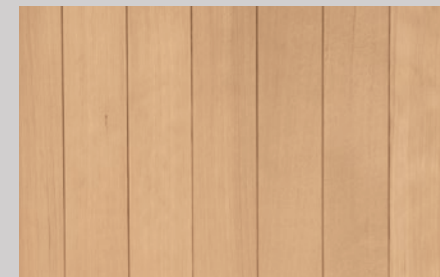

Hemlock

Un legno pregiato, privo di nodi, resistente e dalla tonalità calda. Garantisce la massima coibentazione termica.
A fine, knot-free, and resistant wood with a warm colour. Hemlock ensures extreme thermal insulation.



Abete nodato

I nodi dell'Abete risaltano l'autenticità del legno e valorizzano la naturalezza della sauna.
The knots of the spruce wood the authenticity of the material and the naturalness of the sauna.

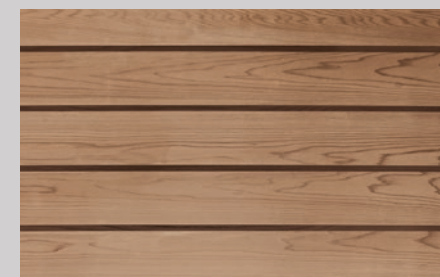

Cedro + Frassino Termotrattato

Il profumo del Cedro diffonde all'interno della sauna l'aroma della natura. Il Frassino termotrattato conferisce ulteriore resistenza.

The natural scent of the cedar is spread all over the sauna. The heat-treated ash wood provides further resistance.

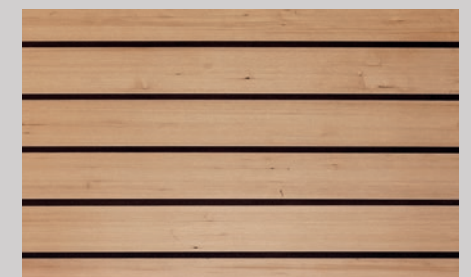

Hemlock + Frassino Termotrattato

Il trattamento termico del Frassino migliora le caratteristiche di durabilità del legno e si unisce alla resistenza dell'Hemlock.

The thermal treatment of ash wood improves its durability, which adds to the Hemlock's resistance.

SUPERFICI SPECIALI INTERNE ED ESTERNE

Special interior and exterior surfaces

Materiali innovativi dalla grande resa estetica e dalle elevate performance caratterizzano le finiture esterne degli ambienti wellness e l'interno di box doccia e hammam. Per questi ambienti costantemente sottoposti a sollecitazioni termiche, abbiamo scelto delle superfici ad alto contenuto tecnologico che, oltre ad essere molto resistenti e a mantenere inalterate le loro proprietà nel tempo, risultano belle da vedere e piacevoli da toccare. Per ambienti funzionali e ricchi di stimoli tattili e visivi.

Beautiful, innovative, and high-performance materials characterise the external finishes of wellness settings and the inside of shower cubicles and Turkish baths. These settings constantly undergo thermal stress. That's why we have chosen high-tech surfaces, which not only resist better and maintain their properties unchanged over time but are also pleasing to the eye and the touch. For functional settings rich in tactile and visual stimuli.



Anti-impronta
Anti-fingerprint



Bassa riflessione
Low reflection



Alta resistenza
High resistance



Resistenza al calore
Resistance to heat



Facile pulizia
Easy to clean

SAUNAVITA®
calore.naturale

FINITURE

Finishes



Struttura esterna ed interna
Spazio doccia e hammam
Exterior and interior structure
Shower space and hammam

Fenix

Un materiale innovativo e resistente per i progetti wellness: con una bassa riflessione della luce, le superfici sono opache, anti-impronte e soft touch.

An innovative and resistant material for wellness projects: with a low reflection of light, the surfaces are matt, anti-fingerprint and soft touch.

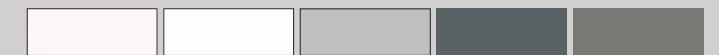

Alaska
Alaska

Bianco Kos
White Kos

Grigio Efeso
Gray Ephesus

Grigio Bromo
Gray Bromo

Grigio Londra
Gray London



Struttura esterna ed interna
Spazio doccia e hammam
Exterior and interior structure
Shower space and hammam

Grigio Cosmico

Una finitura costituita da uno speciale laminato dalle alte prestazioni, altamente impermeabile, resistente e con una resa estetica unica.

A finish consisting of a special high performance laminate, highly waterproof, durable and with a unique aesthetic result.



Grigio Cosmico
Cosmic Gray



Struttura esterna ed interna hammam
Exterior and interior hammam structure

Solid Surface

Un materiale simile alla pietra naturale, composto da minerali naturali e resine acriliche ad alta resistenza, crea superfici solide di nuova generazione.

A material that is similar to natural stone. It is made up of natural minerals and high-resistance resins, and creates state-of-the-art solid surfaces.



Bianco
White

OLIMPO

design FRANCO BERTOLI

La rivoluzione nel mondo della sauna e del bagno turco è realtà: un vero e proprio hammam, con doccia e vasca idromassaggio integrati, viene affiancato da un ambiente sauna per un percorso benessere completo. La vasca interna al bagno turco ha un innovativo sistema di idromassaggio MicroSilk® che avvolge il corpo di micro-bolle benefiche: un elisir di giovinezza per il corpo e per la mente.

A revolution in the world of saunas: a true Turkish bath with built-in shower and whirlpool bath combined with a sauna setting for a complete wellness path.

The tub inside the Turkish bath is equipped with MicroSilk®, an innovative whirlpool system that covers the body with beneficial microbubbles.

A true youth elixir for your body and mind.

**Una vasca interna al bagno turco:
la nuova frontiera dell'idroterapia infonde piacevoli
e autentiche sensazioni di benessere.**

*the new frontier of hydrotherapy that instils
pleasant and authentic feelings of well being.*



Olimpo

collection

DIMENSIONI
395x150x215 H
(hammam 195 cm - sauna 200 cm)

CARATTERISTICHE
hammam con doccia
e vasca integrata + sauna

DIMENSIONS
395x150x215 H
(hammam 195 cm - sauna 200 cm)

SPECIFICATIONS
hammam with shower
and integrated bath + sauna





Una pratica e comoda copertura pieghevole trasforma la vasca in un lettino, se completamente disteso, o in una confortevole seduta, se parzialmente aperto. Può essere usato anche come pratico poggiatesta.

A practical and comfortable cover cushion transforms the bath into a lounger, when fully extended, or into a comfortable seat, if partially opened. It can also be used as a headrest.



VASCA CON SISTEMA DI IDROMASSAGGIO MICROSILK® Tub with microsilk® whirlpool system

Microsilk® è la nuova frontiera dell'idroterapia, un'autentica fonte di benessere e giovinezza. Un getto speciale produce una nuvola di microbolle di ossigeno che idrata la pelle e ha effetti benefici sulla respirazione. (per altre informazioni vedi pag. 280)

Microsilk® is the new frontier of hydrotherapy. An authentic source of wellness and youth. A special jet forms a cloud of oxygen micro bubbles, which hydrates the skin and has beneficial effects on breathing. (for more information see page 280)

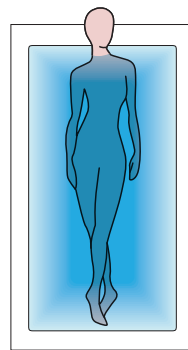

Rilassamento senza getti idromassaggio
Relax without whirlpool jets

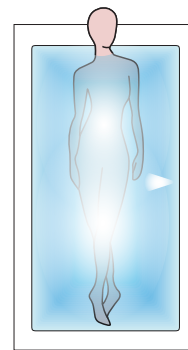

Sistema idromassaggio Microsilk® acceso
Microsilk hydromassage system on

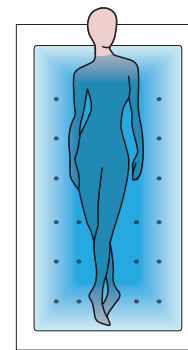

Idromassaggio airpool
Airpool hydromassage

Olimpo collection

Soffioni sequenziali,
attivabili tramite tastiera.

*Sequential head showers,
managed by the control panel.*



Olimpo

collection



**Tastiera per l'attivazione delle funzioni
Microsilik®, Airpool (accessorio), soffioni sequeziali
e rubinetteria termostatica per funzioni hydro.**

*Control panel activating functions
Microsilik®, Airpool (accessory), sequezial shower heads
and theromostatic tap for the hydraulic functions.*

**Erogatore di vapore con aromaterapia
Steam generator with aromatherapy**



**Aggiungendo essenze e aromi all'erogatore di vapore si
aumentano i benefici del bagno turco.**

*By adding essences and aromas to the steam generator,
you increase the benefits of the Turkish bath.*

Olimpo

collection



DIMENSIONI
395x150x215 H

CARATTERISTICHE
hammam con doccia
e vasca integrata + sauna

DIMENSIONS
395x150x215 H

SPECIFICATIONS
hammam with shower
and integrated bath + sauna



La stufa "a torre" con pietre laviche fa raggiungere la temperatura ideale all'ambiente in maniera più veloce e costante rispetto ad una stufa tradizionale. Per un notevole risparmio di energia.

The "tower" stove with lava stones creates the ideal temperature more quickly and consistently compared to traditional ones, allowing for considerable energy savings.



INTERNO



ESTERNO

La maniglia ha una doppia finitura: l'interno in legno si armonizza con il calore della sauna e l'esterno in alluminio ne richiama i profili.

The handle has a double finish. The wood of the inside merges with the heat of the sauna, while the aluminium of the outside matches the profiles.



Touch screen LCD



Touch screen LCD display per il comando remoto delle funzioni.
 LCD touch screen display to manage every function.

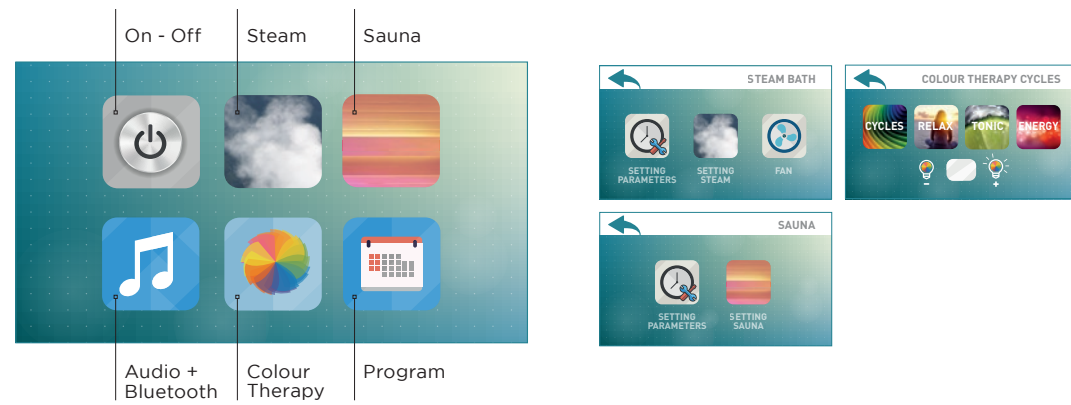

Olimpo

collection

La cromoterapia per una raffinata pratica di benessere.

Chromoterapy for a pleasant and refined wellness.

Olimpo

Sistema combinato da due moduli:

Hammam (con doccia e vasca integrata) + Sauna

System made up of two modules:

Turkish bath (with shower and integrated bath) + Sauna

DIMENSIONI

395x150x215 H
Hammam 195 cm - Sauna 200 cm
Potenza max:
Hammam 4 kW - Sauna 4,5 kW -
Vasca 1,3 kW

355x150x215 H
Hammam 195 cm - Sauna 160 cm
Potenza max:
Hammam 4 kW - Sauna 3,5 kW -
Vasca 1,3 kW

INSTALLAZIONE

Parete - Angolo - Nicchia

CARATTERISTICHE

Basamento con piedini regolabili
Maniglie in alluminio / alluminio legno
Pannello di controllo (sauna e bagno turco) touch screen in vetro serigrafato
Sistema audio con bluetooth
Sauna con mestolo e mastellino in legno
Stufa con pietre
Cromoterapia diffusa a Led RGB con 3 cicli, cambio colore automatico e funzione iride a 42 colori
Poggiaschiena double-face

Spazio doccia con bagno turco e vasca con sistema MicroSilk®
Soffione in acciaio 30x30
Cascata
Rubinetteria termostatica con doccino
2 Cuscini coprivasca con funzione di seduta
Aspiratore
4 soffioni sequenziali posizionati sopra la vasca
Riempimento della vasca con ETP

FINITURE

Esterno: spazio doccia rivestito in Fenix; cristallo temperato da 8 mm con profili in alluminio brillantato
Interno: Sauna con arredamento e rivestimenti in abachi; spazio doccia con bagno turco rivestito in Fenix
Vasca in acrilico Bianco lucido con sistema MicroSilk®
2 cuscini in ecopelle Antracite

MEASUREMENT

395x150x215 H
Turkish bath 195 cm - Sauna 200 cm
Max power: Turkish bath 4 kW -
Sauna 4.5 kW - Tub 1.3 kW

355x150x215 H
Turkish bath 195 cm - Sauna 160 cm
Max power: Turkish bath 4 kW -
Sauna 3.5 kW - Tub 1.3 kW

INSTALLATION

Wall - Corner - Niche

SPECIFICATIONS

Base with adjustable feet
Handles in aluminum / aluminum wood
Screenprinted glass touch-screen control panel (sauna and Turkish bath)
Audio system with bluetooth
Sauna with wooden ladle and small tub
Stove with rocks
RGB Led chromotherapy with 3 cycles, automatic colour change and 42-colour iris function
Reversible backrest
Shower area with Turkish bath and tub with MicroSilk®
Shower-head system in steel 30x30
Waterfall
Thermostatic tap with hand shower
2 folding pillows to cover the bathtub and to lie above or sit
Extractor fan
4 sequential head showers above the bathtub
Bathtub water filling through the overflow

FINITURE

Exterior: shower space covered in Fenix; 8 mm tempered glass structure with polished aluminium edges
Interior: sauna with furniture and cladding in abachi wood; shower area with Turkish bath clad in Fenix
White glossy acrylic bath with MicroSilk® system
2 faux leather anthracite finishing pillows

Misure disponibili / Available sizes



x 2/3 hammam
x 3/4 sauna

395 x 150 x 215 h
Hammam 4 kW
Sauna 4,5 kW
Vasca 1,3 kW



x 2/3 hammam
x 2/3 sauna

355 x 150 x 215 h
Hammam 4 kW
Sauna 3,5 kW
Vasca 1,3 kW

FINITURA SAUNA _ SAUNA FINISH

Interno ed arredamento
Interior and furniture finishes



ABACHI
Perline orizzontali
Horizontal matchboard

FINITURE HAMMAM _ TURKISH BATH FINISHES

Interno ed esterno
Interior and exterior



FENIX
Grigio Efeso
Gray Ephesus
FENIX
Grigio Bromo
Gray Bromo

Olimpo

Sistema combinato da due moduli:
Hamam (con doccia e vasca integrata)

System made up of two modules:
Turkish bath (with shower and integrated bath)

DIMENSIONI

195x150x215 H Hamam
Potenza max:
Hamam 4 kW - Vasca 1,3 kW

INSTALLAZIONE

Parete - Angolo - Nicchia

CARATTERISTICHE

Basamento con piedini regolabili
Maniglie in alluminio
Pannello di controllo (bagno turco)
touch screen in vetro serigrafato
Sistema audio con bluetooth
Cromoterapia diffusa a Led RGB con 3
cicli, cambio colore automatico e funzione
iride a 42 colori
Spazio doccia con bagno turco e vasca
con sistema MicroSilk®
Soffione in acciaio 30x30
Cascata
Rubinetteria termostatica con doccia
2 Cuscini coprivasca con funzione di seduta
Aspiratore
4 soffioni sequenziali posizionati
sopra la vasca
Riempimento della vasca con ETP

FINITURE

Esterno: spazio doccia rivestito in Fenix;
cristallo temperato da 8 mm con profili
in alluminio brillantato
Interno: spazio doccia con bagno turco
rivestito in Fenix
Vasca in acrilico Bianco lucido con
sistema MicroSilk®
2 cuscini in ecopelle Antracite

Misure disponibili / Available sizes



x 2/3 hamam
195 x 150 x 215 h
Hamam 4 kW
Vasca 1,3 kW

MEASUREMENT

195x150x215 H Turkish bath
Max power:
Turkish bath 4 kW - Tub 1.3 kW

INSTALLATION

Wall - Corner - Niche

SPECIFICATIONS

Base with adjustable feet
Handles in aluminum
Screenprinted glass touch-screen
control panel (turkish bath)
Audio system with bluetooth
RGB Led chromotherapy with
3 cycles, automatic colour change
and 42-colour iris function
Shower area with Turkish bath and
tub with MicroSilk®
Shower-head system in steel 30x30
Waterfall
Thermostatic tap with hand shower
2 folding pillows to cover the bathtub
and to lie above or sit
Extractor fan
4 sequential head showers above
the bathtub
Bathtub water filling through
the overflow

FINISHES

Exterior: shower space covered in Fenix;
8 mm tempered glass structure with
polished aluminium edges
Interior: shower area with Turkish
bath clad in Fenix
White glossy acrylic bath with
MicroSilk® system
2 faux leather anthracite
finishing pillowss



Fenix Grigio Bromo
Fenix Gray Bromo



Fenix Grigio Efeso
Fenix Gray Efeso

FINITURE HAMMAM _ TURKISH BATH FINISHES

Interno ed esterno
Interior and exterior



FENIX
Grigio Efeso
Gray Ephesus

FENIX
Grigio Bromo
Gray Bromo

ETHOS

design FRANCO BERTOLI

Tre moduli per comporre un sistema di wellness integrato funzionale ed accogliente con hammam, spazio doccia e sauna fruibili contemporaneamente da una o più persone. Ethos crea la soluzione professionale ideale per piccole spa e strutture ricettive, ma anche per ogni tipo di ambiente domestico.

Three modules to compose a functional and welcoming integrated wellness system with hammam, shower area and sauna that can be used simultaneously by one or more people. Ethos creates the ideal professional solution for small spas and accommodation facilities, but also for every type of home environment.

Liberi di scegliere tra 5 sistemi che combinano bagno turco, spazio doccia e sauna.

Free to choose among 5 systems combining turkish bath, shower and sauna.



SAUNAVITA®
calore naturale

Ethos

collection

ETHOS | collection



DIMENSIONI
400x150x215 H

CARATTERISTICHE
hammam con doccia integrata +
spazio doccia + sauna

DIMENSIONS
400x150x215 H

SPECIFICATIONS
hammam with integrated shower +
shower + sauna

Ethos

collection



Legno Abachi

L'allestimento in legno crea un ambiente confortevole, con panche e poggiaschiena double-face.

Abachi wood

The wooden fittings create a comfortable environment, with benches and double-face backrest.



Apertura pivottante

La comoda apertura a bilico della porta in vetro trasparente o stop sol rende più agevole l'entrata.

Pivoted opening

The convenient pivoted opening of the clear glass or Stopsol door makes entry more comfortable.

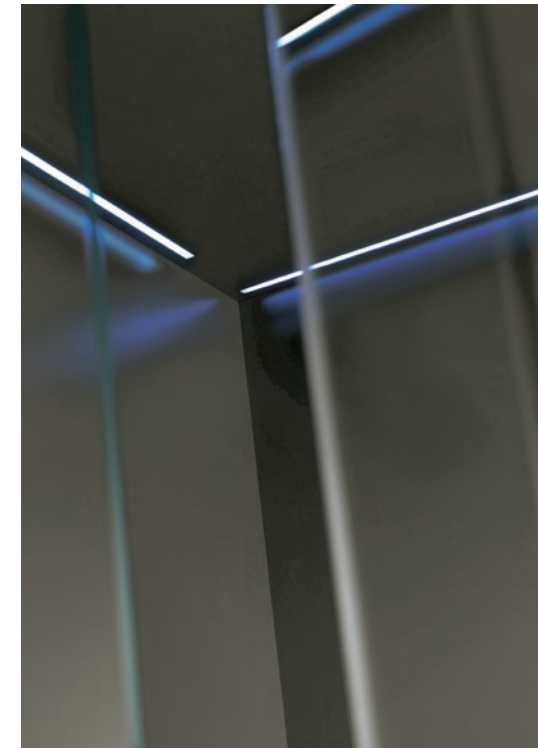

Cromoterapia a led

Un sistema di cromoterapia a led permette di immergersi nella benefica influenza dei colori.

Led colour therapy

A colour therapy system with LEDs lets you immerse yourself in the positive influence of colours.



Ciotola in teak

Una fonte con l'originale ciotolina in teak per avere sempre a disposizione l'acqua fresca.

Teak bowl

A fountain with original teak bowl so that cool water is always available.

Ethos

collection



DIMENSIONI
310x150x215 H

CARATTERISTICHE
hammam con doccia integrata
+ sauna

DIMENSIONS
310x150x215 H

SPECIFICATIONS
hammam with integrated shower
+ sauna

Ethos

collection



DIMENSIONI
252x150x215 H

CARATTERISTICHE
spazio doccia + sauna

DIMENSIONS
252x150x215 H

SPECIFICATIONS
shower + sauna

Ethos

collection



DIMENSIONI
242x150x215 H

CARATTERISTICHE
hammam + spazio doccia

DIMENSIONS
242x150x215 H

SPECIFICATIONS
hammam + shower

Ethos

Finiture - Finishes

Esterno

Porte e fissi in cristallo temperato 8 mm.
Pannelli in laminato.

Exterior

8 mm tempered glass doors and fixed panels.
Laminate panels

Interno

Sauna con arredamenti e rivestimenti in abachi.
Hamam e spazio doccia rivestito con uno speciale laminato in finitura Grigio Cosmico.

Interior

Sauna with abachi wood furnishes and coverings.
Turkish bath and shower area covered with a special laminate Cosmico Gray finish.

Piatto doccia

Piatto doccia in Solid Surface sp. 1,2 supportato da telaio in acciaio con piedini regolabili (sia nella doccia che nell'hammam).

Shower tray

Solid surface shower tray, 1.2 thick, with steel frame and adjustable feet (both in the shower and the Turkish bath).

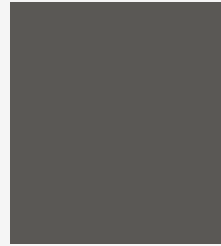

Grigio Cosmico

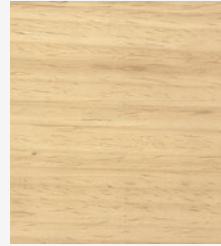

Sauna _ Abachi



Hamam _
Grigio Cosmico



Solid Surface _
Grigio Cosmico

Ethos

Hamam con doccia integrata + Spazio doccia + Sauna Turkish bath with integrated shower + Shower + Sauna

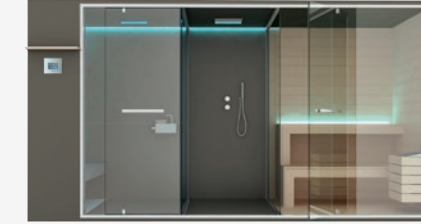

x 2/3 hammam
x 2/3 sauna

400 x 150 x 215 h
Hamam 4 kW
Sauna 3,6 kW

DIMENSIONI

La modularità di Ethos consente di comporre il proprio ambiente wellness personalizzato
400x150x215 H
Potenza max:
Hamam 4 kW - Sauna 3,6 kW

INSTALLAZIONE

Parete - Angolo - Nicchia

CARATTERISTICHE

Basamento con piedini regolabili
Chiusure vetro temperato, spessore 8 mm
Maniglie in alluminio / alluminio legno
Mensola porta essenze
Pannello di controllo (sia per sauna che hammam): pannello touch con finitura in vetro bianco
Sistema audio con bluetooth

MEASUREMENT

The modularity of Ethos lets you create your own wellness space
400x150x215 H
Max power:
Turkish bath 4 kW - Sauna 3.6 kW

INSTALLATION

Wall - Corner - Niche

SPECIFICATIONS

Base with adjustable feet
Tempered glass enclosures, 8 mm thick
Handles in aluminum / aluminum wood
Shelf
Control panel (both for the sauna and the Turkish bath): touch screen panel with white glass finish
Sound system with bluetooth

ACCESSORI SAUNA

Mestolo in legno
Mastellino in legno
Stufa con pietre
Cromoterapia diffusa a Led RGB con 3 cicli, cambio colore automatico e funzione iride a 42 colori
Poggiaschiena double-face

ACCESSORI HAMMAM

Fonte con ciotolina in teak
Erogatore di vapore
Cromoterapia diffusa a Led RGB con 3 cicli, cambio colore automatico e funzione iride a 42 colori
Soffione in acciaio 30x30
Panca in laminato con cromoterapia integrata
Rubinetteria termostatica con doccino

ACCESSORIES SAUNA

Wooden ladle
Wooden bucket
Stove with stones
RGB Led chromotherapy with 3 cycles, automatic colour change and 42-colour iris function
Reversible backrest

ACCESSORIES TURKISH BATH

Source with teak bowl
Steam generator
RGB Led chromotherapy with 3 cycles, automatic colour change and 42-colour iris function
30x30 steel shower head
Laminate bench with integrated chromotherapy
Thermostatic taps with handheld shower head

ACCESSORI SPAZIO DOCCIA

Soffione in acciaio 50x30 con cascata e nebulizzatore integrato
Rubinetteria termostatica con doccino
Cromoterapia diffusa a Led RGB con 3 cicli, cambio colore automatico e funzione iride a 42 colori posizionata nel tetto

ACCESSORIES SHOWER AREA

50x30 steel shower head with waterfall feature and built-in atomiser
Thermostatic taps with handheld shower head
RGB Led chromotherapy with 3 cycles, automatic colour change and 42-colour iris function on the roof

Ethos

Hammam con doccia integrata + Sauna
Turkish bath with integrated shower + Sauna



x 2/3 hammam
x 3/4 sauna
350 x 150 x 215 h
Hammam 4 kW
Sauna 4,5 kW



x 2/3 hammam
x 2/3 sauna
310 x 150 x 215 h
Hammam 4 kW
Sauna 4,5 kW



x 3/4 sauna
295 x 150 x 215 h
Sauna 4,5 kW



x 2/3 sauna
252 x 150 x 215 h
Sauna 3,6 kW

DIMENSIONI

La modularità di Ethos consente di comporre il proprio ambiente wellness personalizzato
350x150x215 H
Potenza max:
Hammam 4 kW - Sauna 4,5 kW
310x150x215 H
Potenza max:
Hammam 4 kW - Sauna 4,5 kW

INSTALLAZIONE

Parete - Angolo - Nicchia

CARATTERISTICHE

Basamento con piedini regolabili
Chiusure vetro temperato, spessore 8 mm
Maniglie in alluminio / alluminio legno
Mensola porta essenze
Pannello di controllo (sia per sauna che hammam): pannello touch con finitura in vetro bianco
Sistema audio con bluetooth

ACCESSORI SAUNA

Mestolo in legno
Mastellino in legno
Stufa con pietre
Cromoterapia diffusa a Led RGB con 3 cicli, cambio colore automatico e funzione iride a 42 colori
Poggiaschiene double-face

ACCESSORI HAMMAM

Fonte con ciotolina in teak
Erogatore di vapore
Cromoterapia diffusa a Led RGB con 3 cicli, cambio colore automatico e funzione iride a 42 colori
Soffione in acciaio 30x30
Panca in laminato con cromoterapia integrata
Rubinetteria termostatica con doccino

DIMENSIONI

La modularità di Ethos consente di comporre il proprio ambiente wellness personalizzato
295x150x215 H
Potenza max: 4,5 kW
252x150x215 H
Potenza max: 3,6 kW

INSTALLAZIONE

Parete - Angolo - Nicchia

CARATTERISTICHE

Basamento con piedini regolabili
Chiusure vetro temperato, spessore 8 mm
Maniglie in alluminio / alluminio legno
Pannello di controllo (sia per sauna che hammam): pannello touch con finitura in vetro bianco
Sistema audio con bluetooth

ACCESSORI SAUNA

Mestolo in legno
Mastellino in legno
Stufa con pietre
Cromoterapia diffusa a Led RGB con 3 cicli, cambio colore automatico e funzione iride a 42 colori
Poggiaschiene double-face

ACCESSORI SPAZIO DOCCIA

Soffione in acciaio 50x30 con cascata e nebulizzatore integrato
Rubinetteria termostatica con doccino
Cromoterapia diffusa a Led RGB con 3 cicli, cambio colore automatico e funzione iride a 42 colori posizionata nel tetto

MEASUREMENT

The modularity of Ethos lets you create your own wellness space
350x150x215 H
Max power:
Turkish bath 4 kW - Sauna 4.5 kW
310x150x215 H
Max power:
Turkish bath 4 kW - Sauna 4.5 kW

INSTALLATION

Wall - Corner - Niche

SPECIFICATIONS

Base with adjustable feet
Tempered glass enclosures, 8 mm thick
Handles in aluminum / aluminum wood
Shelf
Control panel (both for the sauna and the Turkish bath): touch screen panel with white glass finish
Sound system with bluetooth

ACCESSORIES SAUNA

Wooden ladle
Wooden bucket
Stove with stones
RGB Led chromotherapy with 3 cycles, automatic colour change and 42-colour iris function
Reversible backrest

TURKISH BATH

Source with teak bowl
Steam generator
RGB Led chromotherapy with 3 cycles, automatic colour change and 42-colour iris function
30x30 steel shower head
Laminate bench with integrated chromotherapy
Thermostatic taps with handheld shower head

MEASUREMENT

The modularity of Ethos lets you create your own wellness space
295x150x215 H
Max power: 4.5 kW
252x150x215 H
Max power: 3.6 kW

INSTALLATION

Wall - Corner - Niche

SPECIFICATIONS

Base with adjustable feet
Tempered glass enclosures, 8 mm thick
Handles in aluminum / aluminum wood
Control panel (both for the sauna and the Turkish bath): touch screen panel with white glass finish
Sound system with bluetooth

ACCESSORIES SAUNA

Wooden ladle
Wooden bucket
Stove with stones
RGB Led chromotherapy with 3 cycles, automatic colour change and 42-colour iris function
Reversible backrest

ACCESSORIES SHOWER AREA

50x30 steel shower head with waterfall feature and built-in atomiser
Thermostatic taps with handheld shower head
RGB Led chromotherapy with 3 cycles, automatic colour change and 42-colour iris function on the roof

Ethos

Hamмам con doccia integrata + Spazio doccia
Turkish bath with integrated shower + Shower



x 2/3 hammam

242 x 150 x 215 h
 Hammam 4 kW

DIMENSIONI

La modularità di Ethos consente di comporre il proprio ambiente wellness personalizzato
 242x150x215 H
 Potenza max: 4 kW

INSTALLAZIONE

Parete - Angolo - Nicchia

CARATTERISTICHE

Basamento con piedini regolabili
 Chiusure vetro temperato, spessore 8 mm
 Maniglie in alluminio
 Mensola porta essenze
 Pannello di controllo (hammam): pannello touch con finitura in vetro bianco
 Sistema audio con bluetooth

ACCESSORI HAMMAM

Fonte con ciotolina in teak
 Erogatore di vapore
 Cromoterapia diffusa a Led RGB con 3 cicli, cambio colore automatico e funzione iride a 42 colori
 Soffione in acciaio 30x30
 Panca in laminato con cromoterapia integrata
 Rubinetteria termostatica con doccino

ACCESSORI SPAZIO DOCCIA

Soffione in acciaio 50x30 con cascata e nebulizzatore integrato
 Rubinetteria termostatica con doccino
 Cromoterapia diffusa a Led RGB con 3 cicli, cambio colore automatico e funzione iride a 42 colori posizionata nel tetto

MEASUREMENT

The modularity of Ethos lets you create your own wellness space
 242x150x215 H
 Max power: 4 kW

INSTALLATION

Wall - Corner - Niche

SPECIFICATIONS

Base with adjustable feet
 Tempered glass enclosures, 8 mm thick
 Handles in aluminum
 Shelf
 Control panel (Turkish Bath): touch screen panel with white glass finish
 Sound system with bluetooth

ACCESSORIES TURKISH BATH

Source with teak bowl
 Steam generator
 RGB Led chromotherapy with 3 cycles, automatic colour change and 42-colour iris function
 30x30 steel shower head
 Laminate bench with integrated chromotherapy
 Thermostatic taps with handheld shower head

ACCESSORIES SHOWER AREA

50x30 steel shower head with waterfall feature and built-in atomiser
 Thermostatic taps with handheld shower head
 RGB Led chromotherapy with 3 cycles, automatic colour change and 42-colour iris function on the roof

DIMENSIONI

La modularità di Ethos consente di comporre il proprio ambiente wellness personalizzato
 150x150x215 H
 Potenza max: 4 kW

INSTALLAZIONE

Parete - Angolo - Nicchia

Hamмам con doccia integrata
Turkish bath with integrated shower



x 2/3 hammam

150 x 150 x 215 h
 Hammam 4 kW

CARATTERISTICHE

Basamento con piedini regolabili
 Chiusure vetro temperato, spessore 8 mm
 Maniglie in alluminio
 Mensola porta essenze
 Pannello di controllo (hammam): pannello touch con finitura in vetro bianco
 Sistema audio con bluetooth

ACCESSORI HAMMAM

Fonte con ciotolina in teak
 Erogatore di vapore
 Cromoterapia diffusa a Led RGB con 3 cicli, cambio colore automatico e funzione iride a 42 colori
 Soffione in acciaio 30x30
 Panca in laminato con cromoterapia integrata
 Rubinetteria termostatica con doccino

MEASUREMENT

The modularity of Ethos lets you create your own wellness space
 150x150x215 H
 Max power: 4 kW

INSTALLATION

Wall - Corner - Niche

SPECIFICATIONS

Base with adjustable feet
 Tempered glass enclosures, 8 mm thick
 Handles in aluminum
 Shelf
 Control panel (Turkish Bath): touch screen panel with white glass finish
 Sound system with bluetooth

ACCESSORIES TURKISH BATH

Source with teak bowl
 Steam generator
 RGB Led chromotherapy with 3 cycles, automatic colour change and 42-colour iris function
 30x30 steel shower head
 Laminate bench with integrated chromotherapy
 Thermostatic taps with handheld shower head

ETHOS C ETHOS L

design FRANCO BERTOLI

Legni pregiati, materiali tecnologicamente avanzati e soluzioni all'avanguardia che ridisegnano il ruolo della sauna e del bagno turco per gli ambienti domestici e professionali. Ethos C viene implementato con un modulo sauna affiancato dallo spazio doccia con bagno turco integrato.

Fine wood and state-of-the-art materials and solutions revolutionise the sauna and Turkish bath for domestic and professional settings. Ethos C is implemented with a sauna module with an integrated shower and Turkish bath.

Goditi la tua sauna con spazio doccia e bagno turco.

Enjoy your sauna with an integrated shower and Turkish bath area.



Ethos C

collection



DIMENSIONI
252x120x215 H

CARATTERISTICHE
sauna + spazio doccia con bagno turco

DIMENSIONS
252x120x215 H

SPECIFICATIONS
sauna + shower with steam generator

Ethos C - Ethos L

collection

Il rivestimento interno della sauna in Abachi e la cromoterapia portano natura e colori nel relax quotidiano.

The internal coating of sauna is made by Abachi wood and the chromotherapy bring nature and colors into daily relaxation.



Vano tecnico in Fenix

Da doccia a bagno turco: nel vano tecnico della caldaia sono integrati doccino e miscelatori.

Technical box made by Fenix

From shower to turkish bath: in the technical box is located the steam generator and the taps.



Maniglia in Abachi

La maniglia in Abachi è coordinata al rivestimento interno della sauna, per uno stile completo e armonioso.

Abachi wood handles

The Abachi wood handle matches the sauna's internal coating to make the entire setting as harmonious as ever.



Soffione

Un ampio soffione doccia con cascata a lama e getti nebulizzati crea un getto d'acqua avvolgente che rigenera la pelle dopo la sauna.

Shower head

A large shower head with water blade cascade and spray jets provides a water jet that embraces you and reinvigorates your skin after the sauna.



DIMENSIONI
252x120x215 H

CARATTERISTICHE
spazio doccia + sauna

DIMENSIONS
252x120x215 H

SPECIFICATIONS
shower + sauna

Ethos C

collection



L'area doccia in Fenix Grigio Bromo si abbina al vano tecnico e alle finiture esterne.

The bromine grey Fenix shower area perfectly matches the technical compartment and external finishes.

Ethos C 200x100

collection



DIMENSIONI
200x100x215 H

CARATTERISTICHE
sauna + spazio doccia
con bagno turco

DIMENSIONS
200x100x215 H

SPECIFICATIONS
sauna + shower
with steam generator

Ethos L

collection



DIMENSIONI
240x203x215 H

CARATTERISTICHE
sauna + spazio doccia con
bagno turco

DIMENSIONS
240x203x215 H

SPECIFICATIONS
sauna + shower with
steam generator

Ethos C - Ethos L

Sauna + Spazio doccia
Sauna + Shower

DIMENSIONI ETHOS C

295x120x215 H
Sauna 200x120,
doccia con bagno turco 95x120
x2/3 persone
Potenza max: 6,1 kW
(sauna 3,6 kW - bagno turco 2,5 kW)

252x120x215 H
Sauna 160x120,
doccia con bagno turco 92x120
x2/3 persone
Potenza max: 5,5 kW
(sauna 3 kW - bagno turco 2,5 kW)

200x100x215 H
Sauna 115x100,
doccia con bagno turco 85x100
x2 persone
Potenza max: 4,8 kW
(sauna 2,3 kW - bagno turco 2,5 kW)

INSTALLAZIONE

Parete - Angolo - Nicchia

ETHOS C MEASUREMENT

295x120x215 H
Sauna 200x120,
shower space with turkish bath 95x120
x2/3 persons
Max power: 6.1 kW
(sauna 3.6 kW - Turkish bath 2.5 kW)

252x120x215 H
Sauna 160x120,
shower space with turkish bath 95x120
x2/3 persons
Max power: 5.5 kW
(sauna 3 kW - turkish bath 2.5 kW)

200x100x215 H
Sauna 115x100,
shower space with turkish bath 85x100
x2 persons
Max power: 4.8 kW
(sauna 2.3 kW - turkish bath 2,5 kW)

INSTALLATION

Wall - Corner - Niche

DIMENSIONI ETHOS L (Angolo)

240x203x215 H
Sauna 200x120,
doccia con bagno turco 95x120
x2/3 persone
Potenza max: 6,1 kW
(sauna 3,6 kW - bagno turco 2,5 kW)

CARATTERISTICHE

Basamento con piedini regolabili
Chiusure vetro temperato, spessore 8 mm
Pannello di controllo (sia per sauna che hammam): pannello touch con finitura in vetro bianco
Sistema audio con bluetooth
Mestolo in legno
Mastellino in legno
Stufa con pietre
Cromoterapia diffusa a Led RGB con 3 cicli, cambio colore automatico e funzione iride a 42 colori
Poggiaschiene double-face
Sgabello acrilico trasparente 40x24,5x44 H

ETHOS L MEASUREMENT (Corner)

240x203x215 H
Sauna 200x120,
shower space with turkish bath 95x120
x2/3 persons
Max power: 6.1 kW
(sauna 3.6 kW - Turkish bath 2.5 kW)

SPECIFICATIONS

Base with adjustable feet
Tempered glass enclosures, 8 mm thick
Control panel (both for the sauna and the Turkish bath): touch screen panel with white glass finish
Sound system with bluetooth
Wooden ladle
Wooden bucket
Stove with stones
RGB Led chromotherapy with 3 cycles, automatic colour change and 42-colour iris function
Reversible backrest
Transparent acrylic stool 40x24.5x44 H

ACCESSORI

Poggiaschiene double-face (oltre a quello in dotazione)
Fianco di tamponamento per installazione ad angolo

FINITURE

Esterno pareti e porte in cristallo temperato da 8 mm
Interno con arredamenti e rivestimenti in abachi
Maniglie in alluminio / alluminio legno
Pannelli in laminato Fenix: Alaska - Bianco Kos - Grigio Bromo - Grigio Londra - Grigio Efeso

ACCESSORIES

Double face back rest (in addition to the supplied one)
Insulation panel for corner installation

FINISHING

Tempered glass exterior walls and doors from 8 mm
Interior with abachi wood furnishes and coverings
Handles in aluminum / aluminum wood
Laminate panel Fenix: Alaska - White Kos - Gray Bromo - Gray London - Gray Ephesus

FINITURE FENIX _ FENIX FINISHES

Esterno ed interno spazio doccia
Exterior and interior shower

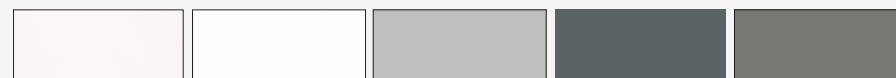

Alaska
Alaska

Bianco Kos
White Kos

Grigio Efeso
Gray Ephesus

Grigio Bromo
Gray Bromo

Grigio Londra
Gray London

Vano tecnico
in finitura Grigio Londra
Technical compartment
in London gray finishing

Vano tecnico
della stessa finitura
Technical compartment
of the same finish

FINITURA SAUNA _ SAUNA FINISH

Interno ed arredamento
Interior and furniture finishes



ABACHI
Perline orizzontali
Horizontal matchboard

Misure disponibili / Available sizes

Ethos C



x 2/3

295 x 120 x 215 h / 6,1 kW
Sauna 200 x 120 / 3,6 kW
Doccia + Hammam 95 x 120 / 2,5 kW

Ethos C



x 2/3

252 x 120 x 215 h / 5,5 kW
Sauna 157 x 120 / 3 kW
Doccia + Hammam 95 x 120 / 2,5 kW

Ethos C



x 2

200 x 100 x 215 h / 4,8 kW
Sauna 115 x 100 / 2,3 kW
Doccia + Hammam 85 x 100 / 2,5 kW

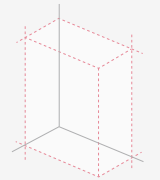

Optional

Misure personalizzate
Custom-made

Ethos L



x 2/3

240 x 203 x 215 h / 6,1 kW
Sauna 200 x 120 / 3,6 kW
Doccia + Hammam 95 x 120 / 2,5 kW

CONSIGLI PER LA SAUNA

Sauna tips



All'interno della sauna si crea un ambiente molto caldo e secco che stimola la sudorazione e l'espulsione delle tossine. Per godere a pieno delle proprietà rilassanti, depurative e rivitalizzanti della sauna, occorre prendersi un po' di tempo e seguire alcuni semplici ma importantissimi passaggi.

The hot and dry environment inside a sauna stimulates transpiration and the elimination of toxins. To fully enjoy the relaxing, purifying, and revitalising properties of a sauna, you need to take your time and follow a few simple but very important steps.

1° Fase

Doccia tiepida
Warm shower



Prima della sauna fai una doccia tiepida per rilassare i muscoli e preparare la pelle dilatando i pori. Poi asciugati e togliti tutto ciò che può riscaldarsi e scottarti.

Take a warm shower before a sauna to relax your muscles and prepare your skin by opening pores. Dry yourself up and remove everything that can heat up and burn you.

2° Fase

Entrata sauna
Sauna



Una volta entrato siediti o distenditi sul livello più basso e meno caldo. La permanenza in sauna a una temperatura di 90°-95° C potrà durare dai 10 ai 15 minuti.

Once in, sit down or lie down at the lowest bench level, which is also the least hot. You can stay in a sauna at a temperature ranging from 90° to 95° C for 10 to 15 minutes.

3° Fase

Doccia fredda
Cold shower



Esci lentamente dalla sauna e fai una doccia o un'immersione fredda: lo sbalzo termico richiude i pori della pelle e stimola la circolazione allenando i vasi sanguigni.

Slowly get out of the sauna and take a cold shower or a cold immersion to close the pores again and stimulate blood circulation.

4° Fase

Relax
Relax



Stenditi su un lettino reclinato e rilassati. Durante la sauna hai perso molti liquidi con la sudorazione, perciò reidratati bevendo dell'acqua.

Lie down on a recliner and relax. You lose plenty of fluids with transpiration, so make sure to drink a lot of water.

5° Fase

Ripetizione sauna
Repeat sauna



Puoi ripetere l'intero ciclo fino a tre volte. Se te la senti, puoi aumentare gradualmente la temperatura a cui sottoponi il corpo sedendoti sui livelli più alti della sauna.

You can repeat the entire cycle up to three times. If you feel like it, you can gradually increase the temperature by sitting at a higher bench level.

GHIBLI SAUNA

design FRANCO BERTOLI

Una gamma che cresce per essere sempre più versatile,
per dare più libertà di scelta e soluzioni per ogni esigenza.

*Selection is improved, it becomes wider and wider,
to reach the best in wellness.*

**Entra nel caldo abbraccio
di una stupenda sauna.**

*Enter in the warm
embrace of a wonderful sauna.*



SAUNAVITA®
calore naturale

Ghibli sauna

collection



DIMENSIONI
150x150x215 H

CARATTERISTICHE
sauna

DIMENSIONS
150x150x215 H

SPECIFICATIONS
sauna

GHIBLI SAUNA | collection



Ghibli sauna
collection

DIMENSIONI
200x150x215 H

CARATTERISTICHE
sauna

DIMENSIONS
200x150x215 H

SPECIFICATIONS
sauna

Ghibli

Sauna

DIMENSIONI

Sauna 200x150x215 H - x3/4 persone
Potenza max: 4,5 kW

Sauna 200x120x215 H - x3/4 persone
Potenza max: 4,5 kW

Sauna 150x150x215 H - x2/3 persone
Potenza max: 3,6 kW

Sauna 150x120x215 H - x2/3 persone
Potenza max: 3,6 kW

Realizzazioni anche su misura

INSTALLAZIONE

Parete - Angolo - Nicchia

CARATTERISTICHE

Basamento con piedini regolabili
Chiusure vetro temperato, spessore 8 mm

Pannello di controllo: pannello touch
con finitura in vetro bianco

Sistema audio con buetooth

Mestolo in legno

Mastellino in legno

Stufa con pietre

Cromoterapia diffusa a Led RGB
con 3 cicli, cambio colore automatico
e funzione iride a 42 colori

Poggiaschiena double-face

FINITURE

Esterno: porta con cerniere pivotanti
e fissi in cristallo temperato da 8 mm

Profili: in alluminio finitura Brill

Interno con arredamenti e rivestimenti
in abachi

Parete sp. 6 cm coibentata con
lana di roccia

MEASUREMENT

Sauna 200x150x215 H - x3/4 persons
Max power: 4.5 kW

Sauna 200x120x215 H - x3/4 persons
Max power: 4.5 kW

Sauna 150x150x215 H - x2/3 persons
Max power: 3.6 kW

Sauna 150x120x215 H - x2/3 persons
Max power: 3.6 kW

Can be custom-made

INSTALLATION

Wall - Corner - Niche

SPECIFICATIONS

Base with adjustable feet

Tempered glass enclosures, 8 mm thick

Control panel: touch screen panel
with white glass finish

Sound system with bluetooth

Wooden ladle

Wooden bucket

Stove with stones

RGB Led chromotherapy with 3 cycles,
automatic colour change and 42-colour
iris function

Reversible backrest

FINISHING

Exterior: 8 mm tempered glass door
with pivot hinges and fixed panels

Profiles: Brill finish aluminium

Interior with abachi wood furnishes
and coverings

Rockwool insulated wall, 6 cm thick

FINITURE FENIX _ FENIX FINISHES

Esterno
Exterior



Alaska
Alaska

Bianco Kos
White Kos

Grigio Efeso
Gray Ephesus

Grigio Bromo
Gray Bromo

Grigio Londra
Gray London

FINITURA SAUNA _ SAUNA FINISH

Interno ed arredamento
Interior and furniture finishes

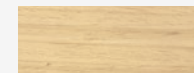

ABACHI
Perline orizzontali
Horizontal matchboard

Misure disponibili / Available sizes



x 3/4
200 x 150 x 215 h
Sauna 4,5 kW



x 3/4
200 x 120 x 215 h
Sauna 4,5 kW



x 2/3
150 x 150 x 215 h
Sauna 3,6 kW



x 2/3
150 x 120 x 215 h
Sauna 3,6 kW

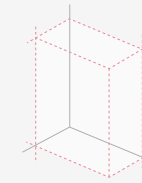

Optional

Misure personalizzate

Custom-made



Installazione a parete con fianco a vista in finitura legno Abachi.

Wall installation with visible side in Abachi wood finish.

Interno e arredamento in legno ABACHI
Interior and furniture in wood Abachi finish

FENIX
Alaska - Bianco Kos - Grigio Bromo - Grigio Londra - Grigio Efeso

Parete laterale in finitura legno ABACHI
Side wall in wood Abachi finish

KALIKA

design STEFANO TONDATO

Le pareti a tutta altezza in cristallo temperato danno forma a una sauna luminosa, alleggerita dai punti luce a led posizionati sopra le sedute. Le panche sospese, la stufa in acciaio e la tastiera digitale uniscono il design alla funzionalità.

The full-height tempered glass walls give shape to a bright sauna, lightened by the LED spotlights positioned above the seats. The suspended benches, the steel heater and the digital keypad combines design and functionality.

**La sauna finlandese che
combina l'eleganza del vetro con
la tradizione del legno.**

*The Finnish sauna, which combines
the elegance of glass with the
tradition of wood.*



Kalika

collection

La luminosa Kalika, con le sue pareti di cristallo da 8 mm a tutta altezza, si trasforma nella sauna perfetta. Alla gamma delle misure standard si aggiunge la possibilità di personalizzare gli ingombri in base agli spazi a disposizione. Tutti gli elementi funzionali della sauna - sedute, panche sospese, stufa - possono essere riconfigurati nella posizione preferita. Perfetta anche nei materiali, da scegliere in base al proprio stile.

What makes Kalika so bright are the 8 mm crystal walls that develop in height. The sauna has never been so perfect! Perfect dimensions: in addition to standard sizes, we give you the opportunity to customise the overall dimensions based on the available space. Perfect composition: all the functional elements of the sauna - chairs, suspended benches, and stove - can be configured in the position you prefer. Perfect materials: to be chosen based on your style.

DIMENSIONI
360x130x214 H

CARATTERISTICHE
sauna

DIMENSIONS
360x130x214 H

SPECIFICATIONS
sauna



Kalika

collection



DIMENSIONI
180x180x215 H

CARATTERISTICHE
sauna

DIMENSIONS
180x180x215 H

SPECIFICATIONS
sauna



Stufa compatta in acciaio con pietre laviche incluse, non richiede protezioni.

Compact steel heater with lava stones included. It does not need any protection.



3,5-4,5-
6-7,5 kW

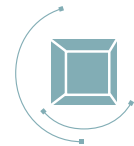

3-8,5 m³

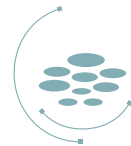

15 kg



Kalika
collection

Sensore di temperatura
Temperature sensor



Camino per aerazione
Ventilation grid





Kalika

collection

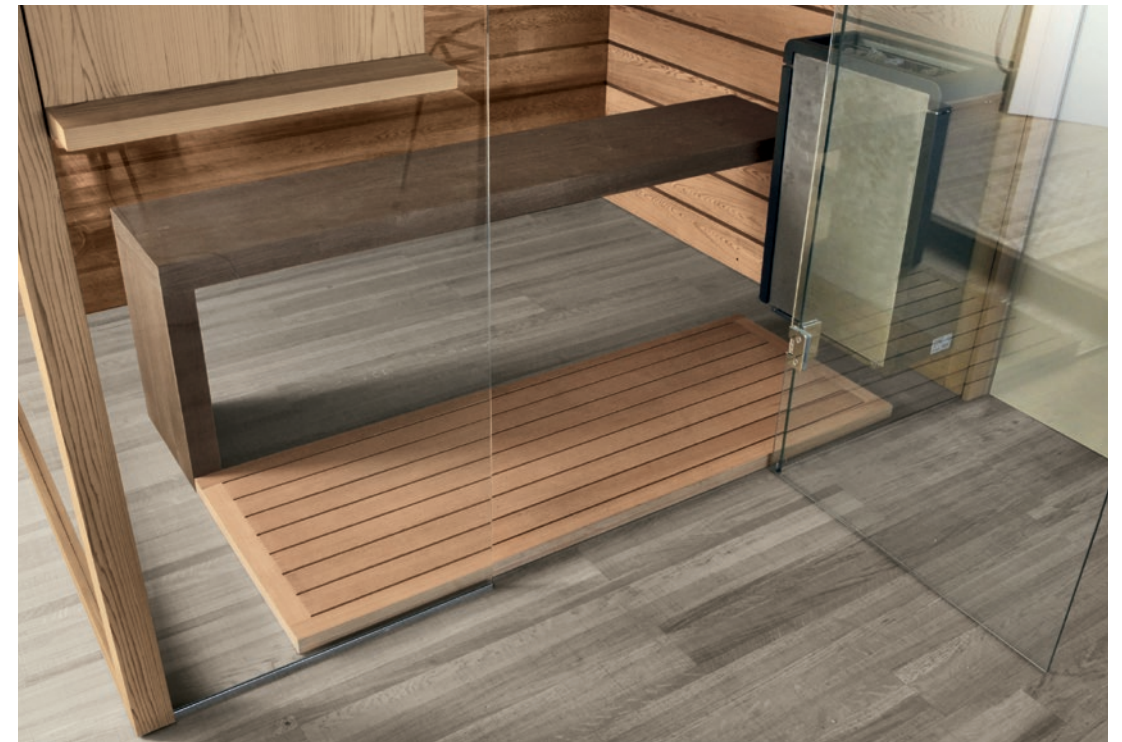

La pedana in legno grigliato, posata sul pavimento, rende confortevole l'ingresso nella sauna.

The wooden slatted footrest will make your sauna experience more comfortable.



Le panche sospese, pensate per l'ergonomia del corpo, sono state alleggerite grazie ad un lavoro di design che le ha rese più funzionali ed accoglienti.

Suspended benches have been designed in harmony with body ergonomics, lightened by an even more functional and welcoming design.



Kalika
collection

DIMENSIONI
160x160x215 H

CARATTERISTICHE
sauna

DIMENSIONS
160x160x215 H

SPECIFICATIONS
sauna



Kalika

collection



Il pannello di controllo touch permette di regolare la temperatura della sauna e di controllarne tutte le funzioni.

The touch control panel allows you to adjust the sauna temperature and control all the functions.



Le fonti luminose a Led posizionate lungo le panche creano nell'ambiente un'atmosfera rilassante.

Led light sources positioned along the benches create a relaxing atmosphere in the environment.

Kalika

collection

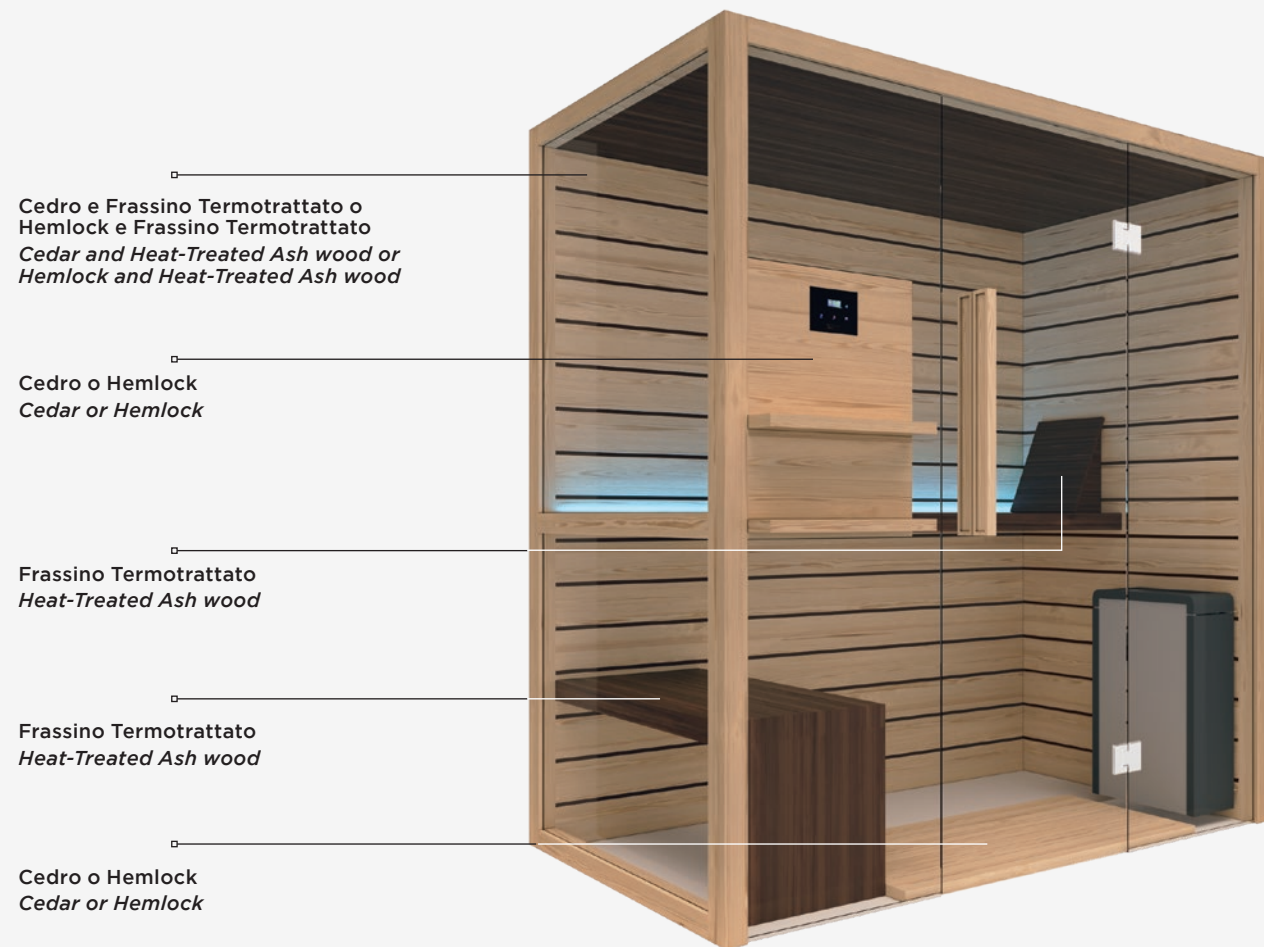

Cedro + Frassino Termotrattato

Cedar + Heat-Treated Ash wood



H perline Cedro: 13,5 cm
 H perline Frassino Termotrattato: 1,5 cm
*Cedar matchboard height: 13.5 cm
 Heat-treated Ash matchboard H: 1.5 cm*

Hemlock + Frassino Termotrattato

Hemlock + Heat-Treated Ash wood



H perline Hemlock: 11,5 cm
 H perline Frassino Termotrattato: 1,5 cm
*Hemlock matchboard height: 11.5 cm
 Heat-treated Ash matchboard H: 1.5 cm*

Angolo / Parete (versione SX)

Corner / Wall (LH version)



Nicchia / Parete / Angolo (versione SX)

Niche / Wall / Corner (LH version)



Kalika

Sauna

DIMENSIONI

Sauna 160x120x215 H - x1/2 persone
Potenza max: 3,45 kW

Sauna 180x120x215 H - x2/3 persone
Potenza max: 3,45 kW

Sauna 200x120x215 H - x3 persone
Potenza max: 4,5 kW

Sauna 160x160x215 H - x3 persone
Potenza max: 4,5 kW

Sauna 180x160x215 H - x3/4 persone
Potenza max: 6,0 kW

Sauna 180x180x215 H - x4/5 persone
Potenza max: 6,0 kW

Sauna 180x200x215 H - x5 persone
Potenza max: 7,5 kW

Sauna 200x160x215 H - x4 persone
Potenza max: 6,0 kW

Sauna 200x180x215 H - x5 persone
Potenza max: 7,5 kW

Sauna 200x200x215 H - x5/6 persone
Potenza max: 7,5 kW

Realizzazioni anche su misura

MEASUREMENT

Sauna 160x120x215 H - x1/2 persons
Max power: 3.45 kW

Sauna 180x120x215 H - x2/3 persons
Max power: 3.45 kW

Sauna 200x120x215 H - x3 persons
Max power: 4.5 kW

Sauna 160x160x215 H - x3 persons
Max power: 4.5 kW

Sauna 180x160x215 H - x3/4 persons
Max power: 6.0 kW

Sauna 180x180x215 H - x4/5 persons
Max power: 6.0 kW

Sauna 180x200x215 H - x5 persons
Max power: 7.5 kW

Sauna 200x160x215 H - x4 persons
Max power: 6.0 kW

Sauna 200x180x215 H - x5 persons
Max power: 7.5 kW

Sauna 200x200x215 H - x5/6 persons
Max power: 7.5 kW

Can be custom-made

CARATTERISTICHE

Basamento con piedini regolabili

Chiusure vetro temperato, spessore 8 mm

Pannello di controllo: touch bluetooth

Sistema audio: 2 casse stereo ausiliarie

Mestolo in legno

Mastellino in legno

Stufa compatta in acciaio con pietre laviche incluse

Cromoterapia diffusa a Led RGB con 3 cicli, cambio colore automatico e funzione iride a 42 colori

Poggiaschiena double-face

Porta battente e fissi in cristallo temperato da 8 mm

Parete sp. 6 cm coibentata con lana di roccia

INSTALLAZIONE

Parete - Angolo - Nicchia

SPECIFICATIONS

Base with adjustable feet

Tempered glass enclosures, 8 mm thick

Control panel: Bluetooth touch

Sound system: 2 auxiliary stereo speakers

Wooden ladle

Wooden bucket

Compact steel heater with stones included.

RGB LED chromotherapy

with 3 cycles, automatic colour change and 42-colour iris function

Reversible backrest

8 mm tempered glass hinged and fixed door

Rockwool insulated wall, 6 cm thick

INSTALLATION

Wall - Corner - Niche

FINITURE

Esterno: struttura in Cedro o Helmock

Interno: doghe in Cedro + Frassino termotrattato o Hemlock + Frassino termotrattato

Panche e tetto in Frassino termotrattato

FINISHING

Exterior: Cedar or Helmock structure

Interior: Cedar slats + Heat-treated ash wood or Hemlock + heat-treated ash wood

Benches and roof made of heat-treated ash wood

FINITURE SAUNA _ SAUNA FINISHES

Esterno Exterior

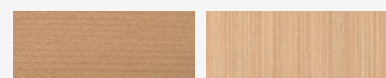

CEDRO

HEMLOCK

Interno Interior

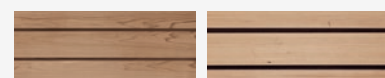
CEDRO +
FRASSINO
TERMOTRATTATOHEMLOCK +
FRASSINO
TERMOTRATTATO

Arredamento Furniture

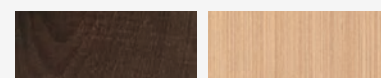
FRASSINO
TERMOTRATTATO

HEMLOCK

Panche, tetto e sedute sospese.
Benches, roof and suspended seats.

Misure disponibili / Available sizes



x 1/2

160 x 120 x 215 h
Sauna 3,45 kW

x 2/3

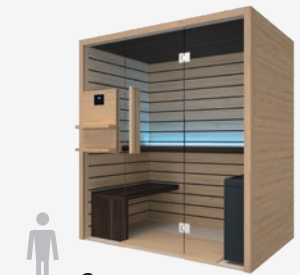
180 x 120 x 215 h
Sauna 3,45 kW

x 3

200 x 120 x 215 h
Sauna 4,5 kW

x 3

160 x 160 x 215 h
Sauna 4,5 kW

x 3/4

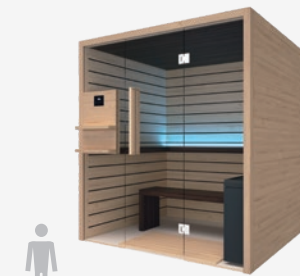
180 x 160 x 215 h
Sauna 6,0 kW

x 4

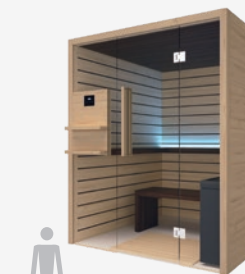
200 x 160 x 215 h
Sauna 6,0 kW

x 4/5

180 x 180 x 215 h
Sauna 6,0 kW

x 5

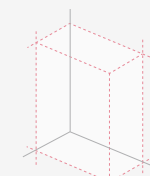
200 x 180 x 215 h
Sauna 7,5 kW

Optional

Misure personalizzate
Custom-made



x 5

180 x 200 x 215 h
Sauna 7,5 kW

x 5/6

200 x 200 x 215 h
Sauna 7,5 kW

CUNA DOCCIA

design FRANCO BERTOLI

Sauna e doccia unite in una pratica combinazione, facilmente inseribile in ogni spazio, per godere dell'antico rito di fuoco e acqua.

Sauna and shower combined in a practical union, easily adaptable in every space, to enjoy some ancient rite of fire and water.

Sauna e doccia vivono insieme anche in piccoli spazi.

Sauna and shower can live together also in a little space.



SAUNAVITA®
calore naturale

Cuna doccia

collection



DIMENSIONI
205x172x204 H

CARATTERISTICHE
sauna + doccia

DIMENSIONS
205x172x204 H

SPECIFICATIONS
sauna + shower

Cuna doccia

collection



Alla cabina doccia si accede mediante una porta con apertura pivotante e maniglia in legno uguale a quella della sauna.

Enter the shower unit via a pivot door featuring a wooden handle match the sauna handle.

Box con soffione integrato, rubinetteria termostatica, doccetta, 4 jets verticali e pedana in multistrato marino.

Cubicle with integrated hot spray, thermostatic taps, shower head, 4 vertical jets and platform in marine plywood.

Cuna doccia

Sauna + Spazio doccia
Sauna + Shower space

DIMENSIONI

205x207x204 H - x3/4 persone
Potenza max: 3,6 kW

205x172x204 H - x2/3 persone
Potenza max: 3 kW

200x92x204 H - x1 persona
Potenza max: 2,3 kW

Realizzazioni anche su misura

INSTALLAZIONE

Parete - Angolo

MEASUREMENT

205x207x204 H - x3/4 persons
Max power: 3.6 kW

205x172x204 H - x2/3 persons
Max power: 3 kW

200x92x204 H - x1 person
Max power: 2.3 kW

Can be custom-made

INSTALLATION

Wall - Corner

CARATTERISTICHE SAUNA

Mestolo in legno

Mastellino in legno

Mensola porta essenze / porta occhiali

Porta salviette

Struttura basamento con piedini regolabili

Cromoterapia diffusa a Led RGB con 3 cicli, cambio colore automatico e funzione iride da 42 colori

Porta vetro temperato, spessore 8 mm

Stufa con pietre

Pannello interno con lastra di protezione ultrapiatta Laminam® (finitura bronzo) posizionata dietro la stufa

Pannello di controllo: pannello touch con finitura in vetro bianco

SPECIFICATIONS SAUNA

Wooden ladle

Wooden bucket

Essence/glasses shelf

Towel holder

Base with adjustable feet

RGB Led chromotherapy with 3 cycles, automatic colour change and 42-colour iris function

Tempered glass door, 8 mm thick

Stove with stones

Interior panel with super-flat Laminam® protection plate (bronze finish) placed behind the stove

Control panel: touch screen panel with white glass finish

CARATTERISTICHE CABINA DOCCIA

Piatto doccia

Pareti attrezzate con rubinetteria termostatica e 4 soffioni verticali

Doccetta

Chiusura con porta battente in cristallo da 8 mm

Pedana in legno multistrato marino

ACCESSORI SAUNA

Poggiaschiene double-face abachi

Vetro Stopsol

Sistema audio con bluetooth

FINITURE

Esterno: hemlock / hemlock e pannello frontale in wenge

Interno: hemlock

Arredamenti: abachi

SPECIFICATIONS SHOWER CUBICLE

Shower tray

Walls with thermostatic taps and 4 vertical jets

Handheld shower head

8 mm safety glass enclosure with hinged door

Marine plywood footboard

ACCESSORIES SAUNA

Abachi wood reversible backrest

Stopsol Glass

Sound system with bluetooth

FINISHES

Exterior: hemlock / hemlock and wenge front panel

Interior: hemlock

Furnitures: abachi wood

FINITURE LEGNO SAUNA _ SAUNA WOOD FINISHES

Esterno
Exterior



HEMLOCK

Interno
Interior



HEMLOCK
Perline orizzontali
Horizontal matchboards

Arredamento
Furniture



ABACHI

SPAZIO DOCCIA _ SHOWER SPACE

Piatto doccia
Shower tray



SOLID SURFACE
Grigio Cosmico

Doccia
Shower



GRIGIO COSMICO

Misure disponibili / Available sizes

Parete Wall



x 1

200 x 92 x 204 h
Potenza max 2,3 kW

Angolo Corner



x 3/4

205 x 207 x 204 h
Potenza max 3,6 kW



x 2/3

205 x 172 x 204 h
Potenza max 2,3 kW

CUNA

design FRANCO BERTOLI

Una sauna finlandese che unisce bellezza estetica e massima funzionalità.
Disponibile in vari modelli e dimensioni, per adattarsi a tutti gli spazi,
Cuna permette di godere dei benefici del calore attraverso un sistema
tecnologico avanzato e materiali ricercati.

*A Finnish sauna that combines beauty and functionality.
Cuna is available in various models and sizes to adapt to any space
and allows you to enjoy all the benefits of heat through an advanced
technological system and refined materials.*

**Il giusto equilibrio tra legno
eco-trattato e vetro di altissima qualità.**

*The perfect balance between eco-treated
wood and top-quality glass.*



SAUNAVITA®
calore naturale

Cuna 165 V

collection



DIMENSIONI
165x127x204 H

CARATTERISTICHE
doppia porta - x2/3 persone
potenza max 3 kW

DIMENSIONS
165x127x204 H

SPECIFICATIONS
double door - x2/3 persons
max power 3 kW

Cuna

collection



L'installazione di un sistema di cromoterapia a Led permette di immergersi nei colori e nella loro benefica influenza per stimolare gioia, energia e per godersi un momento di puro relax.

Led colour therapy systems allows you to immerse into the colours and gain from their beneficial influence to stimulate joy, energy in order to enjoy a well deserved relax.

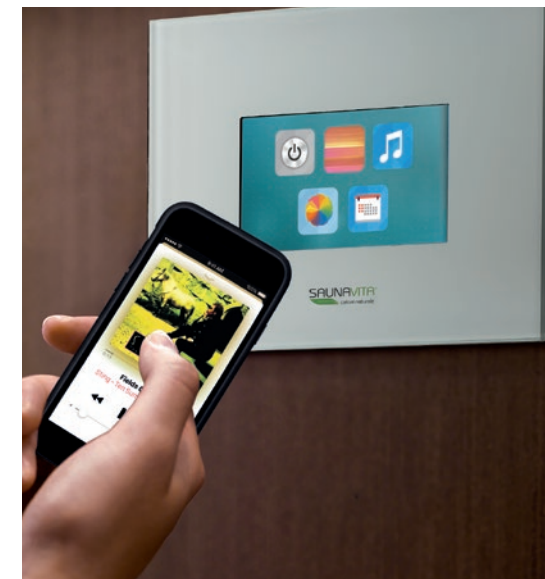

La musica si diffonde nella sauna grazie a un sistema audio con bluetooth da collegare allo smartphone.

The music spreads in the sauna thanks to an audio system with bluetooth to connect to the smartphone.



La stufa, centro naturale della sauna, è in una posizione assolutamente sicura e può essere separata dalla struttura con un pannello in Laminam®, materiale altamente tecnologico che consente una totale protezione dal calore. Il Laminam® non ha solo ottime prestazioni tecniche, ma anche un gradevole aspetto che ben si inserisce nell'accurata estetica della sauna.

The heater, natural center of the sauna, is located in a safe place and it's isolated from the framework by a LAMINAM® panel, an highly technological material that allows a total protection from the heat. LAMINAM® doesn't have only good technical performances, but also a pleasant aspect that perfectly match with the accurate aesthetics of the sauna.

Cuna

Sauna

DIMENSIONI

200x142x204 H - x3/4 persone
Potenza max: 4,5 kW
205x127x204 H - x3 persone
Potenza max: 3,6 kW
165x127x204 H - x2/3 persone
Potenza max: 3 kW
150x127x204 H - x2/3 persone
Potenza max: 3 kW
205x92x204 H - x2/3 persone
Potenza max: 3 kW
165x92x204 H - x2 persone
Potenza max: 2,3 kW
120x127x204 H - x2 persone
Potenza max: 2,3 kW
120x127x204 H (curvo) - x2 persone
Potenza max: 2,3 kW
120x92x204 H (in 2 versioni) - x1 persona
Potenza max: 2,3 kW

Realizzazioni anche su misura

MEASUREMENT

200x142x204 H - x3/4 persons
Max power: 4.5 kW
205x127x204 H - x3 persons
Max power: 3.6 kW
165x127x204 H - x2/3 persons
Max power: 3 kW
150x127x204 H - x2/3 persons
Max power: 2.3 kW
205x92x204 H - x2/3 persons
Max power: 3 kW
165x92x204 H - x2 persons
Max power: 2.3 kW
120x127x204 H - x2 persons
Max power: 2.3 kW
120x127x204 H (curved) - x2 persons
Max power: 2.3 kW
120x92x204 H (in 2 versions) - x1 persons
Max power: 2.3 kW

Can be custom-made

INSTALLAZIONE

Parete - Angolo - Nicchia

CARATTERISTICHE

Mestolo in legno
Mastellino in legno
Mensola porta essenze / porta occhiali
Porta salviette
Struttura basamento con piedini regolabili
Cromoterapia diffusa a Led RGB con 3 cicli, cambio colore automatico e funzione iride da 42 colori
Chiusure vetro temperato, spessore 8 mm
Stufa con pietre
Pannello interno con lastra di protezione ultrapiatta Laminam® (finitura bronzo) posizionata dietro la stufa
Pannello di controllo: pannello touch con finitura in vetro bianco

INSTALLATION

Wall - Corner - Niche

SPECIFICATIONS

Wooden ladle
Wooden bucket
Essence/glasses shelf
Towel holder
Base with adjustable feet
RGB Led chromotherapy with 3 cycles, automatic colour change and 42-colour iris function
Tempered glass enclosures, 8 mm thick
Stove with stones
Interior panel with super-flat Laminam® protection plate (bronze finish) placed behind the stove
Control panel: touch screen panel with white glass finish

ACCESSORI

Poggiaschiene double-face abachi
Vetro Stopsol
Sistema audio con bluetooth

FINITURE

Esterno: hemlock / hemlock e pannello frontale in wengè
Interno: hemlock
Arredamenti: abachi

ACCESSORIES

Abachi wood reversible backrest
Stopsol Glass
Sound system with bluetooth

FINISHES

Exterior: hemlock / hemlock and wenge front panel
Interior: hemlock
Furnitures: abachi wood

Misure disponibili / Available sizes



x 1

120 x 92 x 204 h
Potenza max 2,3 kW



x 1

120 x 92 x 204 h
Potenza max 2,3 kW



x 2

120 x 127 x 204 h
Potenza max 2,3 kW



x 2

120 x 127 x 204 h
Potenza max 2,3 kW



x 2/3

150 x 127 x 204 h
Potenza max 2,3 kW



x 2

165 x 92 x 204 h
Potenza max 2,3 kW



x 2/3

165 x 127 x 204 h
Potenza max 3 kW



x 2/3

165 x 127 x 204 h
Potenza max 3 kW



x 3

200 x 127 x 204 h
Potenza max 3,6 kW



x 3/4

200 x 142 x 204 h
Potenza max 4,5 kW



x 2/3

205 x 92 x 204 h
Potenza max 2,3 kW



x 3

205 x 127 x 204 h
Potenza max 3,6 kW

FINITURE SAUNA _ SAUNA FINISHES

Esterno
Exterior

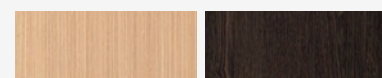

HEMLOCK

WENGÈ

Pannello frontale
Front panel

Interno
Interior

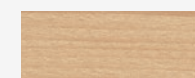

HEMLOCK

Perline orizzontali
Horizontal
matchboards

Arredamento
Furniture

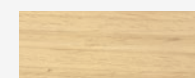

ABACHI

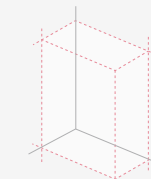

Optional

Misure personalizzate
Custom-made

TALIA

design FRANCO BERTOLI

La sauna è realizzata interamente in abete di risonanza. L'illuminazione interna crea un particolare effetto raggiato grazie all'azione della luce diffusa da una speciale lampada sulle doghe del rivestimento. L'arredo è completato da una panca in abete. La maniglia sempre in legno è integrata in tutto il lato lungo della porta per una presa sicura ed una naturale presenza decorativa.

The sauna is made entirely of fir resonance. The inner lighting creates a unique ray effect thanks to the diffused light fitted to the wooden staved wall.

A fir bench completes the furnishing. The wooden handle is integrated on the entire length of the door to provide an easy, safe grip and a natural decorative presence.

**Una sauna in abete per portare
in casa la natura.**

*Bring nature to your home with
a spruce wood sauna.*



SAUNAVITA®
calore naturale



DIMENSIONI
120x127x204 H

CARATTERISTICHE
x2 persone
potenza max 2,3 kW

DIMENSIONS
120x127x204 H

SPECIFICATIONS
x2 people
max power 2.3 kW

Talia

collection

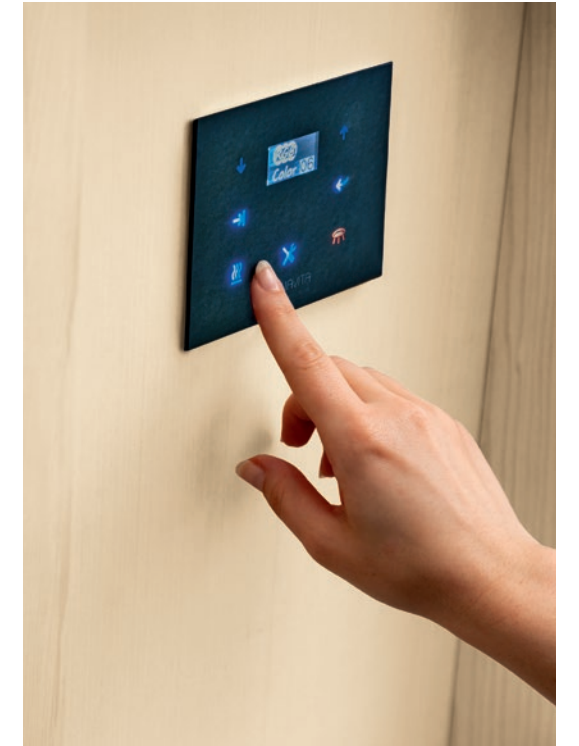

Il pannello di controllo digitale permette di gestire tutte le funzioni della sauna con facilità. La lampada interna diffonde la luce con un particolare effetto raggiato.

The digital control panel easily manages all the sauna's functions. The internal lamp create a unique ray effect.

Talia

Sauna

DIMENSIONI

300x192x204 H - x6 persone
Potenza max: 9 kW
250x192x204 H - x4/5 persone
Potenza max: 9 kW
200x192x204 H - x4 persone
Potenza max: 6 kW
200x142x204 H - x3/4 persone
Potenza max: 4,5 kW
160x127x204 H - x2/3 persone
Potenza max: 3 kW
120x127x204 H - x2 persone
Potenza max: 2,3 kW
120x92x204 H - x1 persona
Potenza max: 2,3 kW

Realizzazioni anche su misura

INSTALLAZIONE

Parete - Angolo - Nicchia

MEASUREMENT

300x192x204 H - x6 persons
Max power: 9 kW
250x192x204 H - x4/5 persons
Max power: 9 kW
200x192x204 H - x4 persons
Max power: 6 kW
200x142x204 H - x3/4 persons
Max power: 4.5 kW
160x127x204 H - x2/3 persons
Max power: 3 kW
120x127x204 H - x2 persons
Max power: 2.3 kW
120x92x204 H - x1 person
Max power: 2.3 kW

Can be custom-made

INSTALLATION

Wall - Corner - Niche

ACCESSORI SAUNA

Poggiaschiene double-face abete
Poggiatesta abete
Vetro Stopsol (optional)
Sistema audio con bluetooth
Cromoterapia diffusa a Led RGB con 3 cicli, cambio colore automatico e funzione iride da 42 colori (sostituisce la lampada interna di serie)
Fungo di emergenza
Protezione in Laminam®

CARATTERISTICHE

Mestolo in legno
Mastellino in legno
Mensola porta essenze / porta occhiali
Porta salviette
Porta accappatoi

ACCESSORIES SAUNA

Reversible spruce backrest
Spruce headrest
Stopsol glass (optional)
Sound system with bluetooth
RGB Led chromotherapy with 3 cycles, automatic colour change and 42-colour iris function (replaces the standard interior light)
Emergency mushroom button
Laminam® protection

SPECIFICATIONS

Wooden ladle
Wooden bucket
Essence/glasses shelf
Towel holder
Bathrobe hook

Lampada interna 220w

Basamento con piedini regolabili
Porta vetro temperato, spessore 6 mm
Cerniere regolabili su tre dimensioni
Stufa con pietre
Pannello di controllo: pannello digitale dotato di display grafico LCD blu retroilluminato a Led bianchi; orologio con datario, controllo e gestione tempo e temperatura; preimpostazione di accensione e clessidra elettronica

FINITURE

Esterno: abete
Interno: abete
Arredamenti: abete

220w interior light

Base with adjustable feet
Tempered glass door, 6 mm thick
Three-dimensional adjustable hinges
Stove with stones
Control panel: digital panel equipped with white Led backlit blue LCD display; date clock, time and temperature control; switch-on pre-setting and electronic hour glass

FINISHES

Exterior: spruce
Interior: spruce
Furnitures: spruce

FINITURE SAUNA _ SAUNA FINISHES

Esterno Exterior



ABETE
Perline verticali
Vertical matchboard

Interno Interior



ABETE
Perline verticali
Vertical matchboard

Arredamento Furniture



ABETE

Misure disponibili / Available sizes



x 6
300 x 192 x 204 h
Potenza max 9 kW



x 4/5
250 x 192 x 204 h
Potenza max 9 kW



x 4
200 x 192 x 204 h
Potenza max 6 kW



x 3/4
200 x 142 x 204 h
Potenza max 4,5 kW



x 2/3
160 x 127 x 204 h
Potenza max 3 kW



x 2
120 x 127 x 204 h
Potenza max 2,3 kW
dx-sx

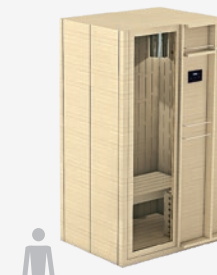

x 1
120 x 92 x 204 h
Potenza max 2,3 kW

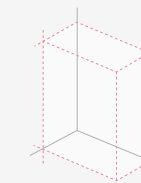

Optional
Misure personalizzate
Custom-made

KYRA

design FRANCO BERTOLI

Linee semplici e la continuità delle forme, Kyra trasforma la sauna in un oggetto d'arredo che si adatta ad ogni ambiente domestico.

La trasparenza del cristallo, la luce diffusa dalla lampada interna e i legni pregiati, infondono benessere e riportano alla più pura tradizione finlandese. Kyra è un bagno di calore che, grazie alla stufa con pietre vulcaniche, rigenera corpo e mente.

Kyra's simple lines and continuity of shapes make this sauna a true piece of furniture, which perfectly adapts to every domestic setting.

The transparency of glass, the light of the internal lamp, and fine wood, foster a sense of wellness and celebrate the true Finnish tradition.

Kyra is a true heat bath, which regenerates both your body and mind, thanks to the heater with lava stones.

**Proprietà terapeutiche
unite al design.**

*Therapeutic properties
combined with design.*



Kyra

collection



DIMENSIONI
246x192x204 H

CARATTERISTICHE
sauna finitura Hemlock

DIMENSIONS
246x192x204 H

SPECIFICATIONS
sauna Hemlock finish

Kyra
collection



Doghe in Abete nodato

I nodi del legno e le doghe disposte in verticale caratterizzano una sauna naturale nell'essenza e moderna nel design.

Spruce wood slats with knots

The knots of the wood and the slats placed vertically make this sauna extremely natural in its essence and modern in its design.

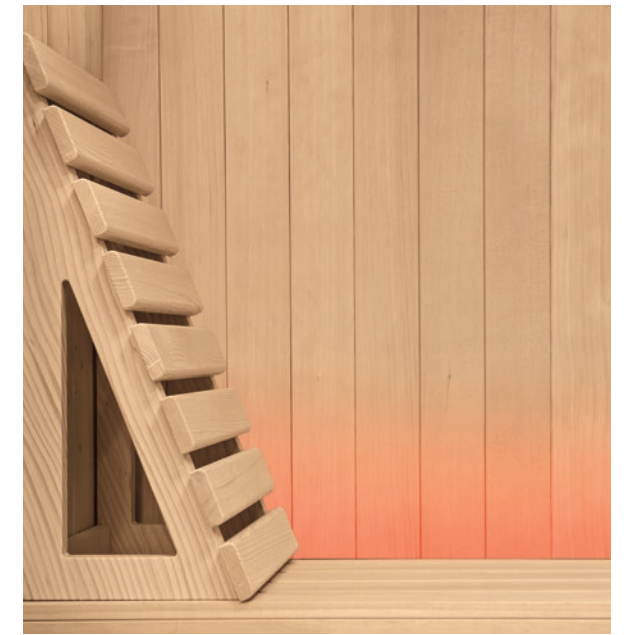

Doghe in Hemlock

Il calore del legno si unisce all'orientamento verticale delle doghe per esprimere lo stile nordico ed essenziale della sauna.

Hemlock slats

The warmth of the wood combined with the vertical slats summarises the essential Northern style of this sauna.

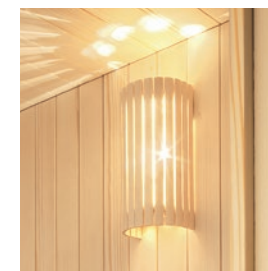

Lampada interna
Internal lamp



Camino per aerazione
Ventilation grid



Cerniera
Hinge



Kyra
collection

DIMENSIONI
246x192x204 H

CARATTERISTICHE
sauna finitura Abete

DIMENSIONS
246x192x204 H

SPECIFICATIONS
sauna Spruce finish

Kyra

collection

DIMENSIONI
192x192x204 H

CARATTERISTICHE
sauna finitura Abete

DIMENSIONS
192x192x204 H

SPECIFICATIONS
sauna Spruce finish



Kyra

collection



Le funzioni della sauna sono controllate da una tastiera digitale, di facile utilizzo, perfettamente integrata nella forma e nello stile di Kyra.

The sauna functions are controlled on a touch screen, easy to use, which blends in seamlessly with the structure and style of Kyra.



DIMENSIONI
150x120x215 H

CARATTERISTICHE
sauna finitura Hemlock

DIMENSIONS
150x120x215 H

SPECIFICATIONS
sauna Hemlock finish

Kyra

Sauna

DIMENSIONI

Sauna 246x246x204 H - x6 persone
Potenza max: 9 kW

Sauna 246x192x204 H - x5/6 persone
Potenza max: 9 kW

Sauna 246x156x204 H - x5 persone
Potenza max: 6 kW

Sauna 192x192x204 H - x4/5 persone
Potenza max: 6 kW

Sauna 192x156x204 H - x4 persone
Potenza max: 4,5 kW

Sauna 192x120x204 H - x3/4 persone
Potenza max: 3,6 kW

Sauna 156x156x204 H - x3/4 persone
Potenza max: 3,6 kW

Sauna 156x120x204 H - x2/3 persone
Potenza max: 3 kW

Sauna 156x102x204 H - x2 persone
Potenza max: 3 kW

Sauna 120x102x204 H - x1 persona
Potenza max: 2,3 kW

MEASUREMENT

Sauna 246x246x204 H - x6 persons
Max power: 9 kW

Sauna 246x192x204 H - x5/6 persons
Max power: 9 kW

Sauna 246x156x204 H - x5 persons
Max power: 6 kW

Sauna 192x192x204 H - x4/5 persons
Max power: 6 kW

Sauna 192x156x204 H - x4 persons
Max power: 4.5 kW

Sauna 156x156x204 H - x3/4 persons
Max power: 3.6 kW

Sauna 192x120x204 H - x3/4 persons
Max power: 3.6 kW

Sauna 156x120x204 H - x2/3 persons
Max power: 3 kW

Sauna 156x102x204 H - x2 persons
Max power: 3 kW

Sauna 120x102x204 H - x1 person
Max power: 2.3 kW

INSTALLAZIONE

Parete - Angolo - Nicchia

CARATTERISTICHE

Mestolo in legno
Mastellino in legno
Lampada interna 220w
Basamento con piedini regolabili
Porta vetro temperato, spessore 8 mm
Cerniere per posizionamento porta 180°
Stufa con pietre
Pannello di controllo: pannello digitale retroilluminato a Led (funzione On/Off - Luce - selezione Temperatura)
Clessidra

INSTALLATION

Wall - Corner - Niche

SPECIFICATIONS

Wooden ladle
Wooden bucket
220w interior light
Base with adjustable feet
Tempered glass door, 8 mm thick
180° door hinges
Stove with stones
Control panel: Led backlit digital panel (On/Off - Light - Temperature selection)
Hourglass

ACCESSORI SAUNA

Poggiaschiena double-face abachi
Poggiatesta abachi
Cromoterapia
Fungo di emergenza

FINITURE

Esterno: abete / hemlock
Interno: abete / hemlock
Arredamenti: abachi
Coibentazione in lana di roccia

ACCESSORIES SAUNA

Reversible abachi wood backrest
Abachi wood headrest
Chromotherapy
Emergency mushroom button

FINISHES

Exterior: spruce / hemlock
Interior: spruce / hemlock
Furnitures: abachi wood
Rockwool insulation

FINITURE SAUNA _ SAUNA FINISHES

Esterno e interno
Exterior and interior



ABETE NODATO
Perline verticali
Vertical matchboard

HEMLOCK
Perline verticali
Vertical matchboard

Arredamento
Furniture



ABACHI

Misure disponibili / Available sizes



x 1

120 x 102 x 204 h
Potenza max 2,3 kW



x 2

120 x 120 x 204 h
Potenza max 3 kW



x 2

156 x 102 x 204 h
Potenza max 3 kW



x 2/3

156 x 120 x 204 h
Potenza max 3 kW

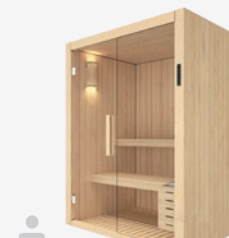

x 3/4

156 x 156 x 204 h
Potenza max 3,6 kW



x 3/4

192 x 120 x 204 h
Potenza max 3,6 kW

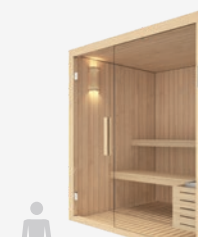

x 4

192 x 156 x 204 h
Potenza max 4,5 kW



x 4/5

192 x 192 x 204 h
Potenza max 6 kW



x 5

246 x 156 x 204 h
Potenza max 6 kW

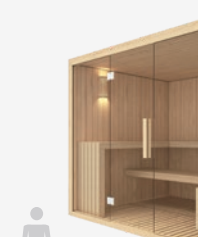

x 5/6

246 x 192 x 204 h
Potenza max 9 kW

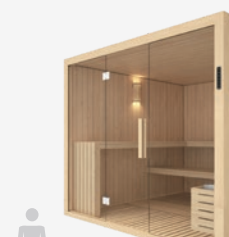

x 6

246 x 246 x 204 h
Potenza max 9 kW

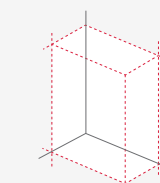

Optional
Misure personalizzate
Custom-made

SAUNE OUTDOOR

Outdoor saunas

Possibili realizzazioni a progetto di saune per esterno. Sauna Vita ti permette di vivere l'esperienza della sauna anche negli spazi esterni, per bagni di calore immersi nella natura. Le saune outdoor diventano oasi di benessere in cui rilassarsi da soli o da condividere con gli altri.

Possible projects for outdoor saunas.

Sauna Vita allows you to experience the sauna also outdoors, immersed in nature. Outdoor saunas become a wellness oasis, where you can relax alone or in good company.





Ogni elemento della sauna è testimone di qualità e pregio: dai materiali, al design, fino ai dettagli più piccoli, come le cerniere.

Each element of the sauna is a testimony to quality and value: from materials, to design, to the smallest details, such as hinges.



Discreto e pratico, il tastierino touch consente di impostare dall'esterno la temperatura. Un elemento funzionale che si integra perfettamente con lo stile della sauna.

Discreet and practical, the touch digital control allows you to set the temperature from outside. A functional element that integrates perfectly with the style of the sauna.



La porta battente sigilla l'ambiente, garantendo che all'interno la temperatura rimanga costante, senza essere influenzata dalle condizioni esterne.

The hinged door seals the sauna area, ensuring that the temperature remains constant inside, without being influenced by external conditions.

SOFFIONE EMOZIONALE

Multi-sensory shower head

Due programmi per stimolare tutti i sensi.

Dopo la sauna, l'ideale è concedersi una doccia di benessere per ridurre la temperatura del corpo e prolungare il relax. Il soffione emozionale, rettangolare o rotondo, è composto da due programmi e una doccia verticale: la "nebbia fredda" nebulizzata con essenza Balsamic e cromoterapia blu crea una piacevole sensazione di freschezza; la "cascata tropicale" calda fa scorrere l'acqua infondendo energia attraverso la cromoterapia con luce rossa e l'essenza Vanilla. Un benessere completo.

Two programmes to stimulate the senses.

After the sauna, take a shower to reduce the body temperature and extend your moment of relaxation. The round or rectangular sensory shower head features two programmes and a vertical shower. The sprayed cold mist with Balsamic essence and blue chromotherapy provides a pleasant hint of freshness. The hot "tropical cascade" makes water flow instilling energy through chromotherapy with red light and Vanilla essence. So regenerating!

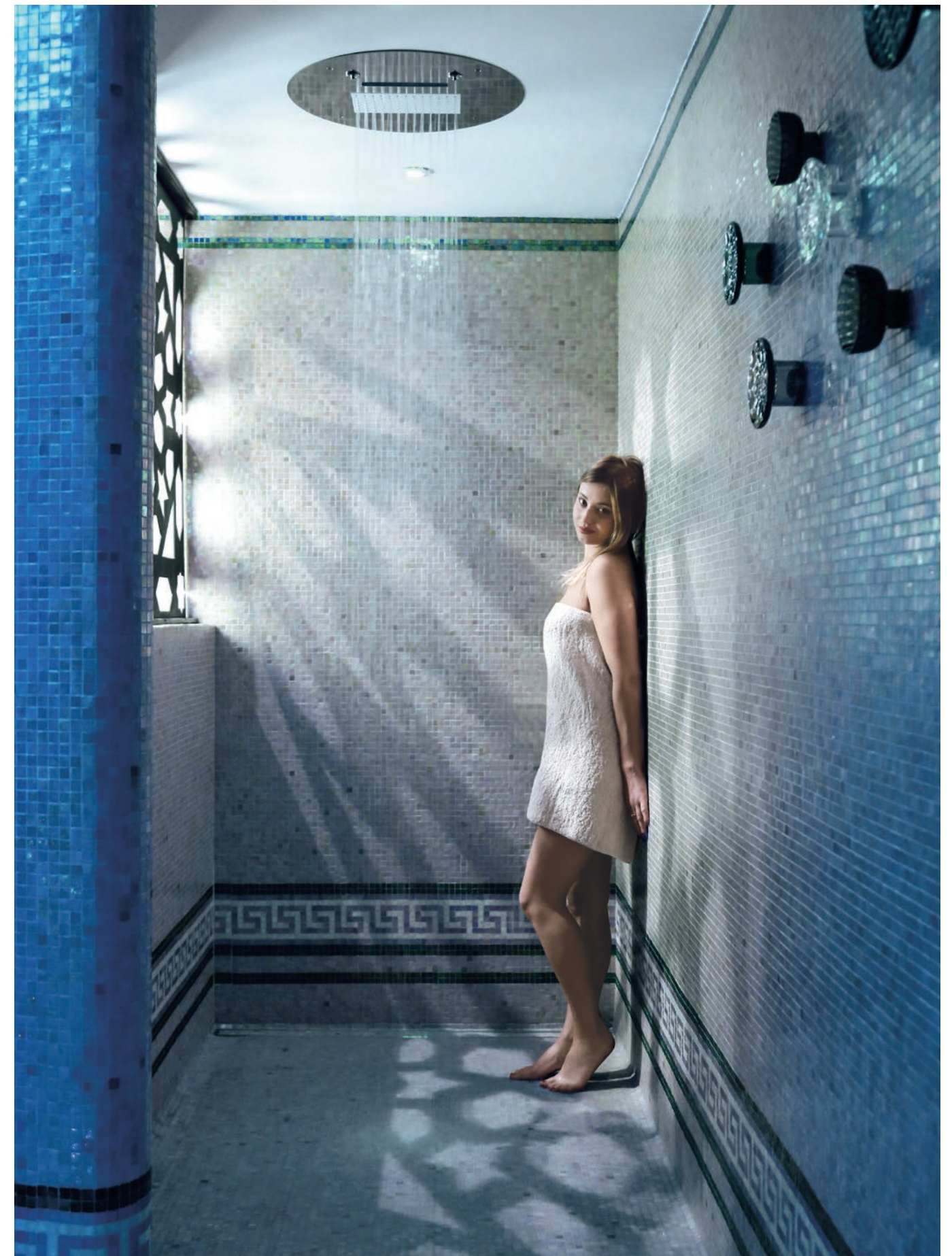

Esempio di installazione in una cabina doccia.

Example of shower cubicle installation.

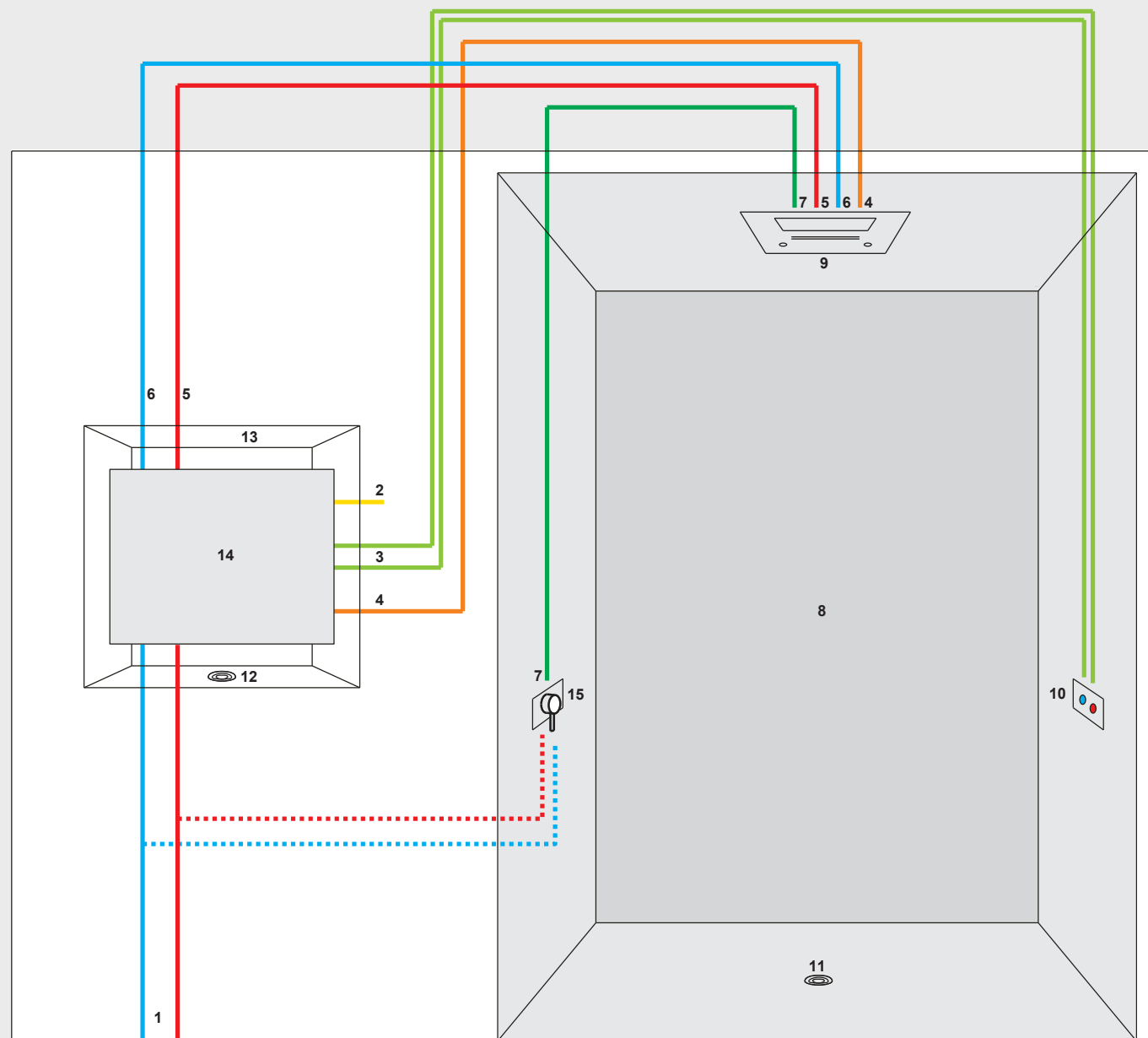

DETTAGLI TECNICI

1. Alimentazione acqua calda e fredda
2. Alimentazione elettrica
3. Collegamento tastiera
4. Collegamento cromoterapia
5. Uscita acqua calda (per cascata)
6. Uscita acqua fredda (per nebulizzatori)
7. Uscita acqua miscelata (per soffione)
8. Cabina doccia
9. Soffione emozionale
10. Tastiera
11. Scarico
12. Scarico opzionale di sicurezza
13. Vano tecnico
14. Pannello elettroidraulico
15. Miscelatore

TECHNICAL DETAILS

1. Hot and cold water supply
2. Power supply
3. Keyboard shortcut
4. Nk chromotherapy
5. Hot water output (for cascading)
6. Cold water outlet (for nebulizers)
7. Water mixer output (for head)
8. Shower box
9. Showerheads emotional
10. Keyboard
11. Exhaust
12. Discharge of security optional
13. Technical room
14. Electro panel
15. Mixer

Soffione rotondo Round showerheads

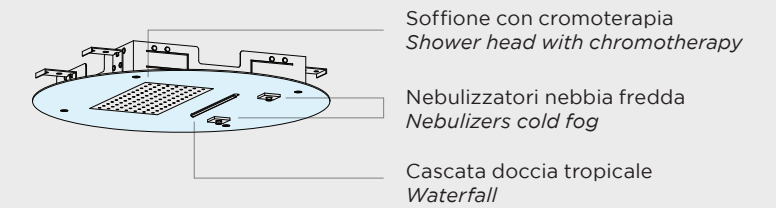

Soffione rettangolare Rectangular showerheads

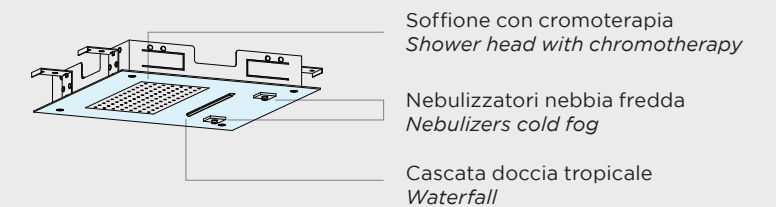

Tastiera Keyboard

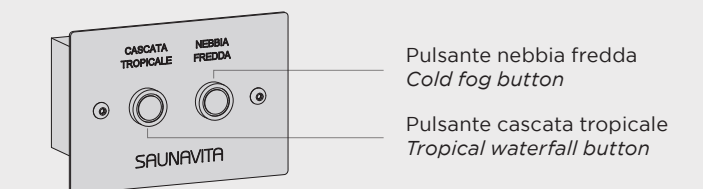

DOCCIA SCOZZESE

Bucket shower

Per rinfrescare intensamente e velocemente il corpo dopo la sauna.
L'impianto è composto da un mastellino in Larice verniciato con una capacità dai 4,5 ai 7,5 litri, provvisto di supporto da fissare a parete, di attacco per l'alimentazione idraulica e di galleggiante per il riempimento automatico. Il mastellino si riempie automaticamente di acqua fredda e tirando una catenella lunga 65 cm il mastellino rovescia di colpo l'acqua sulla persona sottostante.

To cool intensely and quickly our body after sauna.
Shower bucket is made by treated larch wood with capacity from 4.5 to 7.5 liters, provided with a support for wall fixing, hydraulic connections and floater for automatic filling. Bucket will be automatically filled with cold water and pushing a 65 cm long side chain it shots water on the person below.

SAUNAVITA®
calore naturale



Installazione doccia scozzese

Installation bucket shower

INSTALLAZIONE A SOFFITTO

Ceiling installation

Fisso _ Fixed

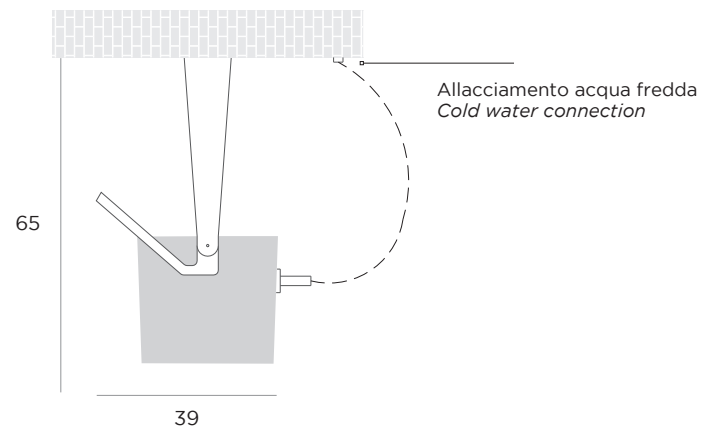

In azione _ In action

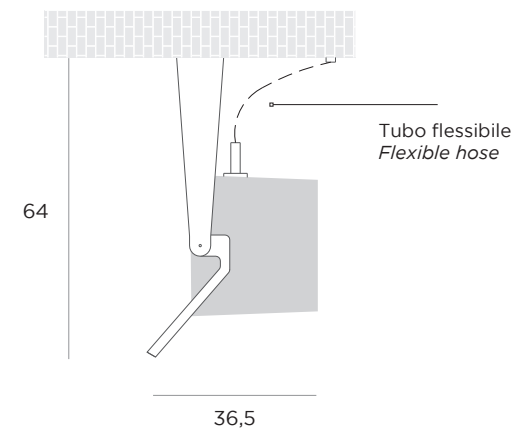

INSTALLAZIONE A PARETE

Wall installation

Fisso _ Fixed

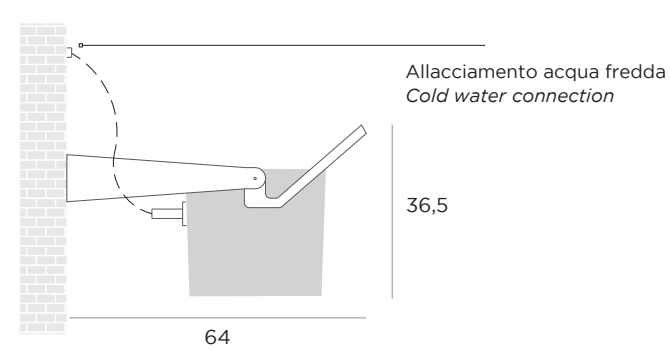

In azione _ In action

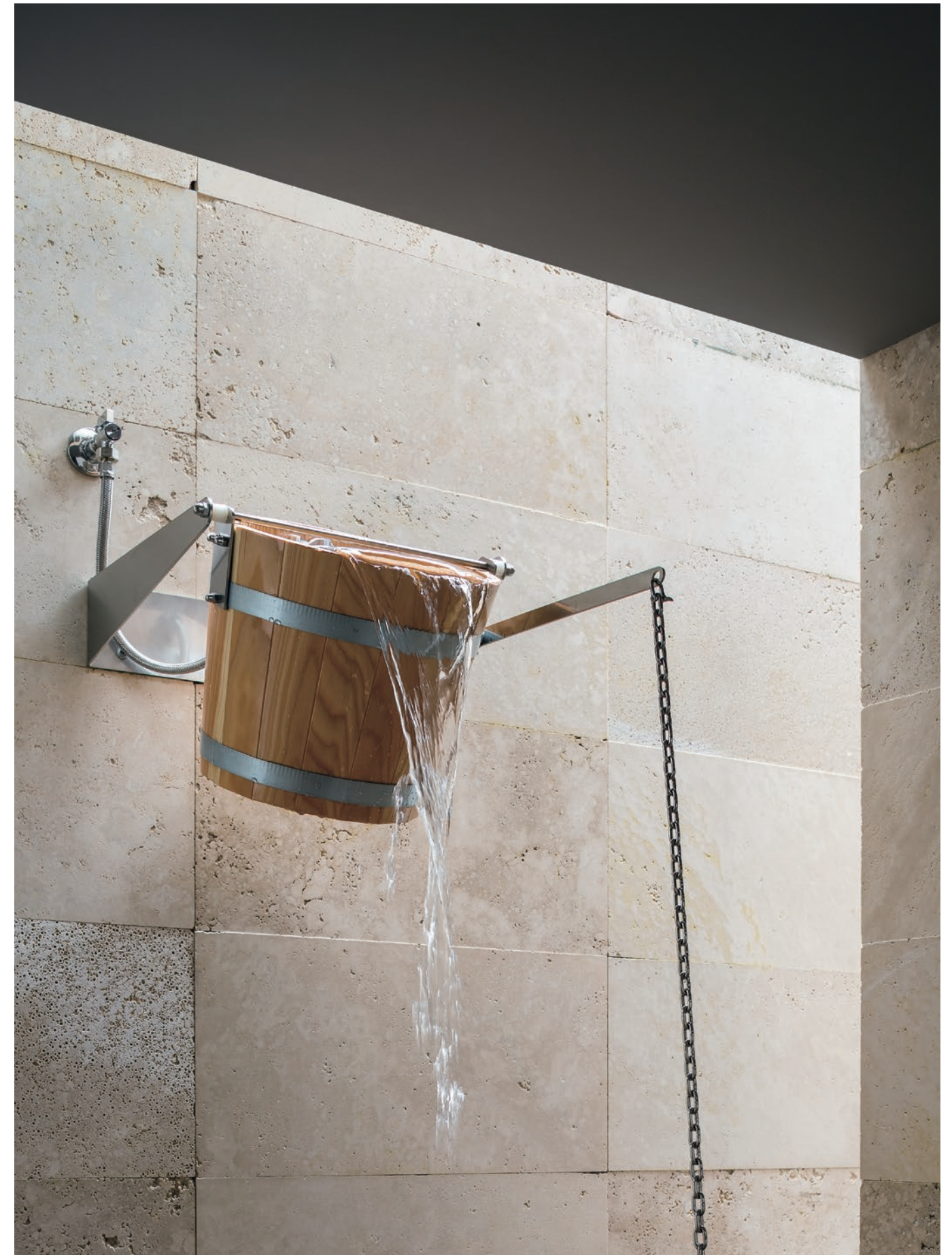
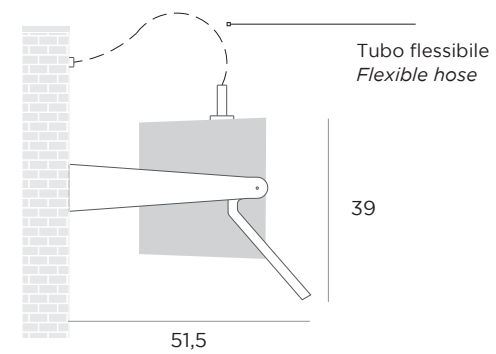



HAMMAM

Hammam

Ghibli ¹⁶⁰

Generatori di vapore
Steam generator

Sv Steam ¹⁷⁰

Sv Steam Mini ¹⁸³

Sv Steam Urus ¹⁸⁴

Sv Steam Plus ¹⁸⁵

Strutture in EPS e soffitti ¹⁸⁸
Smooth EPS structures and ceilings

Porte e vetrate con tenuta vapore ¹⁹⁰
Steam seal doors and windows

Circondati da una nebbia tiepida e avvolgente, ci si abbandona ad una profonda sensazione di relax. All'interno dell'Hammam, la temperatura si aggira intorno ai 45° C e il tasso di umidità arriva al 100%. Rispetto alla sauna, il calore meno intenso e il vapore consentono una permanenza più lunga e una maggiore perdita di liquidi. L'intensa sudorazione porta equilibrio e benessere in tutto il corpo. I pori si dilatano e la pelle si purifica in profondità risultando più elastica e luminosa. Il bagno turco facilita l'eliminazione delle tossine, favorendo la regolazione nervosa e ormonale, con effetti positivi sullo stress, le tensioni muscolari e i dolori reumatici. Inoltre, allevia le infiammazioni alle vie respiratorie e aiuta a combattere l'insonnia e i segni dell'invecchiamento. Entrare in un bagno di vapore significa lasciarsi circondare e invadere dai suoi effluvi benefici, ci si concentra su sé stessi e sull'ascolto del proprio corpo, sperimentando una rigenerante sensazione di calma e distensione.

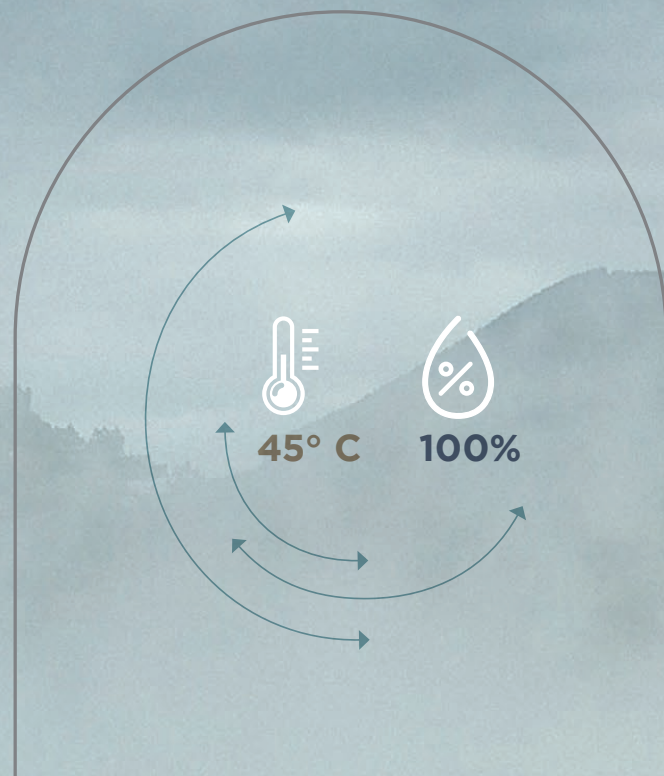

Let its warm and relaxing mist envelop you. The temperature in a Turkish bath is around 45 °C with a 100% humidity rate. The less intense heat compared to the sauna and the steam allow you to stay longer and for greater fluid loss. Intense transpiration brings balance and wellbeing to your whole body. Pores open and your skin is purified in depth becoming bouncier and more radiant. The Turkish bath helps eliminate toxins while promoting nervous and hormonal balance and combating stress, muscle tension, and rheumatic pain. Moreover, it alleviates airway inflammation and helps counter insomnia and signs of ageing. When you step into a steam bath, you focus on yourself and on listening to your body while experiencing a regenerating sensation of calmness and relaxation.

LA FORZA BENEFICA DEL VAPORE

The power of steam

Una delle più radicate certezze dell'uomo è che l'acqua è fonte di vita. Anche quando assume la forma di una calda nuvola di vapore, questo elemento può agire positivamente e in profondità sulla salute del corpo.

Lo sapevano bene in tempi lontani i popoli orientali e i romani, per i quali la SPA (salus per aquam) e i bagni di vapore erano parte integrante della vita quotidiana.

Oggi, il bagno turco sfrutta nuovi materiali e nuove tecnologie, per perfezionare ed amplificare gli effetti positivi di questa pratica antica.

One of few certainties of humankind is that water is a source of life. When it takes the form of a warm cloud of steam, it can even have a deep and positive impact on your body's health. Oriental populations and the Romans already knew this in ancient times. In fact, spas (salus per aquam) and steam baths were an integral part of their day-to-day life. Today, Turkish baths exploit new technologies and materials to amplify the positive effects of this ancient ritual.

GHIBLI

design FRANCO BERTOLI

Ghibli è un modello di hammam e doccia "chiavi in mano" completo di generatore e struttura coibentante, da installare senza opere di muratura e subito pronto. Ghibli semplifica ogni cosa: niente interventi in muratura, niente allestimenti complessi, tempi di attesa e più figure professionali da coordinare.

Ghibli viene realizzato in tre dimensioni pensate per accogliere una o più persone. Le tre misure facilitano l'inserimento in ogni tipologia di ambiente per soddisfare al meglio le esigenze di spazio, mantenendo inalterate le qualità tecniche ed estetiche.

Ghibli is a turkish model of hammam and shower complete with steam generator and insulating structure, to be installed without masonry work and ready to go. Ghibli simplifies everything: no masonry work, no complex preparations, waiting times and more professionals to coordinate. Ghibli is available in three sizes designed to accommodate one or more persons. The three dimensions facilitate the inclusion in any type of setting to match the needs of space at the best, while maintaining the technical and aesthetic qualities.

Ecco l'Hamмам con doccia subito pronto, a casa tua!

The Turkish model of Hammam and shower is ready, in your own home!



SAUNAVITA®
calore naturale

Ghibli

collection



DIMENSIONI
150x150x215 H

CARATTERISTICHE
bagno turco

DIMENSIONS
150x150x215 H

SPECIFICATIONS
turkish bath



Ghibli

collection

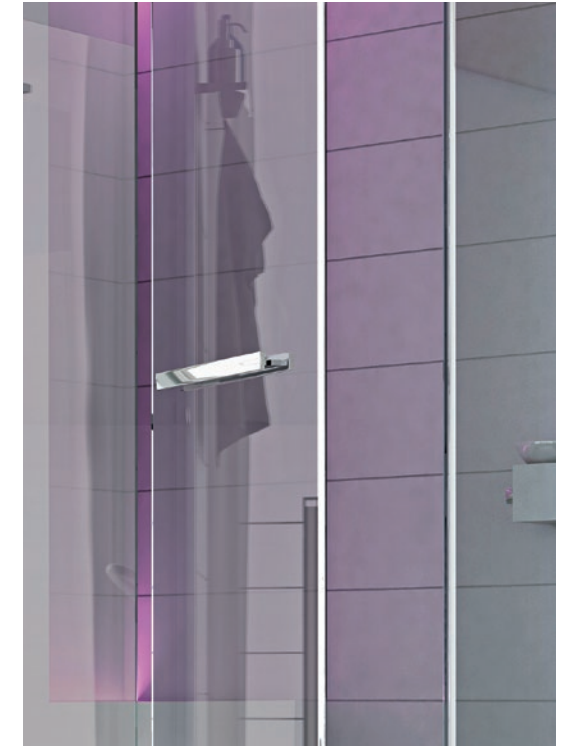

Panca con cromoterapia

La luce integrata nella seduta diffonde in tutto l'ambiente sauna i benefici della cromoterapia.

Bench with chromotherapy

The light integrated in the seat spreads the benefits of chromotherapy all over the sauna.

Maniglia

La maniglia orizzontale applicata consente una comoda apertura e la finitura è coordinata al profilo.

Handle

The horizontal handle allows for easy opening and the finish matches the profile.

Ghibli

collection



DIMENSIONI
150x90x215 H

CARATTERISTICHE
bagno turco

DIMENSIONS
150x90x215 H

SPECIFICATIONS
turkish bath

Ghibli

Hamam
Turkish bath

DIMENSIONI

150x150x215 H - x3/4 persone
Potenza max: 4,1 kW
150x120x215 H - x2/3 persone
Potenza max: 3,1 kW
150x90x215 H - x1 persona
Potenza max: 3,1 kW

INSTALLAZIONE

Angolo

CARATTERISTICHE

Struttura basamento con piedini regolabili
Chiusure vetro temperato, spessore 8 mm
Pannello di controllo: pannello touch con finitura in vetro bianco
Sistema audio con bluetooth
Fonte con ciotolina in Solid Surface
Erogatore di vapore
Cromoterapia diffusa a Led RGB con 3 cicli, cambio colore automatico e funzione iride a 42 colori integrata su tetto e panca
Soffione in acciaio 30x30
Miscelatore termostatico con doccino
Mensola porta essenze / porta occhiali in Solid Surface e acciaio

FINITURE

Esterno ed interno in Solid Surface
Maniglia alluminio Brill
Pareti coibentate in poliuretano
Profili alluminio Brillantato
Piatto in Solid Surface

MEASUREMENT

150x150x215 H - x3/4 persons
Max power: 4.1 kW
150x120x215 H - x2/3 persons
Max power: 3.1 kW
150x90x215 H - x1 person
Max power: 3.1 kW

INSTALLATION

Corner

SPECIFICATIONS

Base with adjustable feet
Tempered glass enclosures, 8 mm thick
Control panel: touch screen panel with white glass finish
Sound system with bluetooth
Source with Solid Surface bowl
Steam generator
RGB Led chromotherapy with 3 cycles, automatic colour change and 42-colour iris function integrated on the roof and bench
30x30 steel shower head
Thermostatic mixer with handheld shower head
Solid surface and steel essence / glasses shelf

FINISHING

Solid surface exterior and interior
Brill finish aluminium handle
Polyurethane insulated walls
Brill finish aluminium profiles
Solid surface tray

Misure disponibili / Available sizes



x 3/4
150 x 150 x 215 h
Potenza max 4,1 kW



x 2/3
150 x 120 x 215 h
Potenza max 3,1 kW



x 1
150 x 90 x 215 h
Potenza max 3,1 kW

FINITURA BAGNO TURCO _ TIRKISH BATH FINISH

Esterno e interno
Exterior and interior

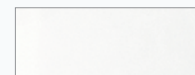

SOLID SURFACE

SV STEAM

collection

Il design sobrio, il colore bianco e le dimensioni ridotte rendono Sv Steam un oggetto d'arredo che può essere installato a vista. Il generatore di vapore per hammam unisce design e prestazioni per rispondere alle nuove esigenze estetiche e funzionali degli ambienti wellness. Una porta in cristallo permette il corretto funzionamento del bagno turco e contiene la massima tecnologia oggi espressa nel campo della produzione di vapore. La tastiera touch rende facile e intuitivo l'utilizzo e il controllo di tutte le funzioni.

The simple design, white colour, and reduced dimensions make Sv Steam a piece of furniture that can be installed at sight. The steam generator for Turkish baths combines design and performance to meet new aesthetic and functional requirements of wellness settings. A glass door allows for the correct operation of the Turkish bath and features state-of-the-art technology in terms of steam production. The touch keypad makes all the functions easy to use.

**Il generatore di vapore diventa
elemento d'arredo.**

*The steam generator turns
into a piece of furniture.*



SAUNAVITA®
calore naturale

GENERATORE DI VAPORE PER LA CASA E LA SPA

Steam generator for your home and spa

SV STEAM offre più soluzioni di hammam per la casa e le Spa, con una diversa localizzazione del generatore di vapore: da incassare o posizionare in vani tecnici dedicati. Tecnologia avanzata per una nuova modalità di allestimento.

Two different hammam proposals, both for residential and Spa, with two different positions of the steam generator: encased into the wall or installed externally in a technical space. Advanced technology to create a new way of setting up.

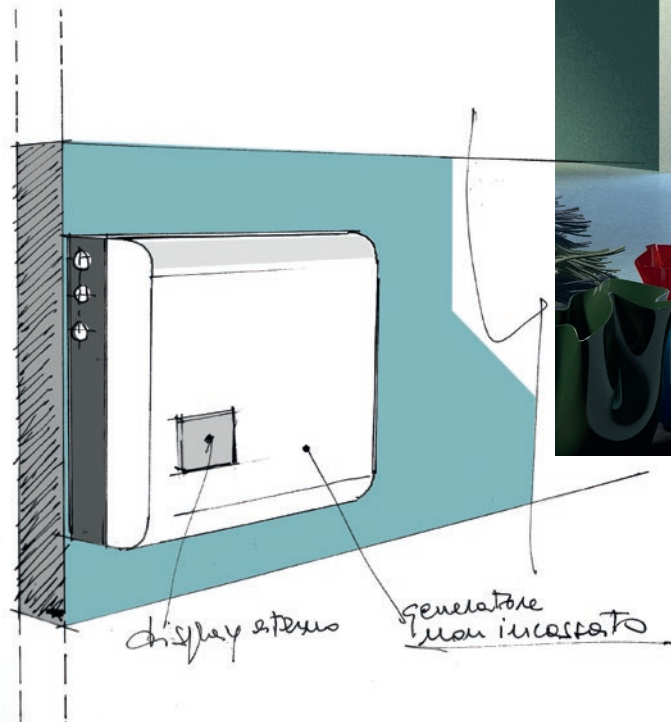

PERSONALIZZAZIONE E COMFORT

Customisation and comfort

È possibile rendere unico l'hammam con angoli lavabo e sedute a muro rivestibili, lineari o curve, con o senza schienale. Un'ampia gamma di soluzioni per venire incontro ad ogni esigenza di spazio, stile e comodità, sia in casa che negli ambienti professionali.

Make your Turkish bath unique with washbasins and wall-mount coverable seats (linear or curved) with or without a backrest. A wide range of solutions to meet any requirement of space, style, and comfort both at home and in professional settings.

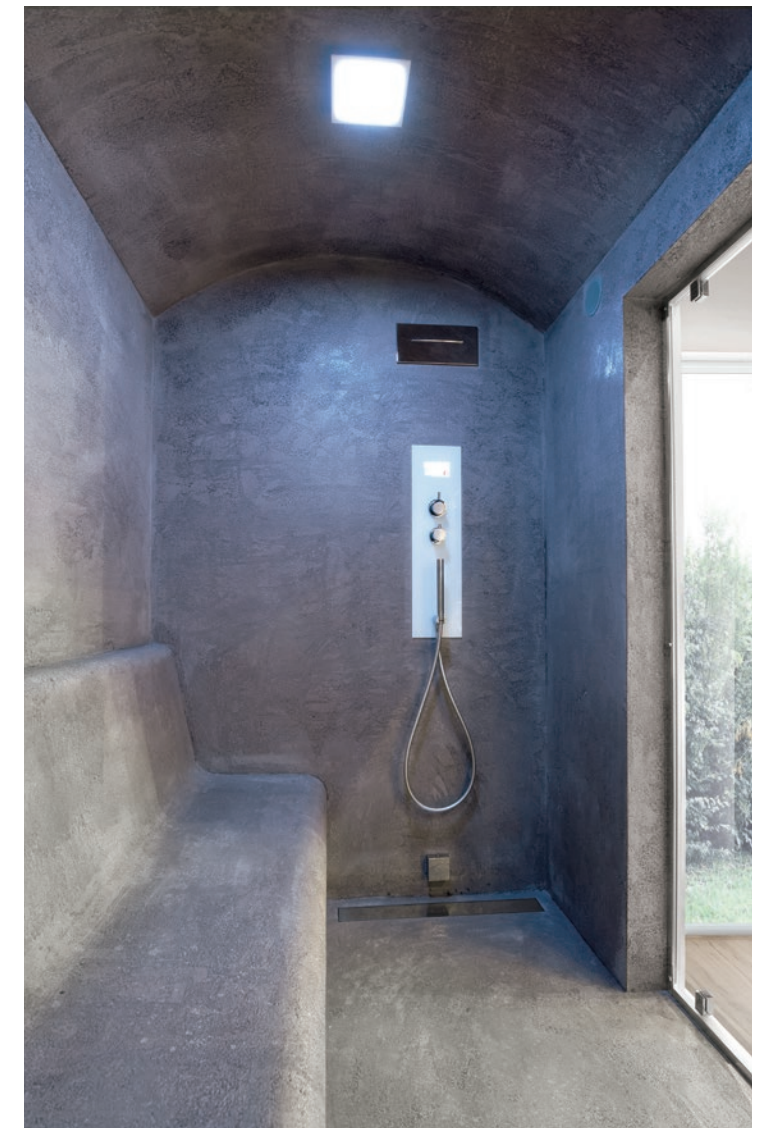

Sv Steam

collection



Sv Steam MINI

CARATTERISTICHE
stanza 160 x 160 con generatore
sv steam mini esterno

SPECIFICATIONS
160 x 160 with exterior version
mounting small steam generator

Sv Steam

collection



Sv Steam

senza display a bordo
without LCD integrated display

CARATTERISTICHE

stanza 250x150 con generatore
sv steam semi-incasso

SPECIFICATIONS

250x150 with semi-encased
mounting steam generator

Sv Steam

collection

STRUTTURA PORTANTE IN EPS

Support structure in EPS

Il polistirene espanso sinterizzato è un materiale atossico, caratterizzato da un elevato isolamento termico e una grande resistenza all'umidità, perfetto per la coibentazione del bagno turco. La struttura in EPS può essere rivestita con mosaici o altri tipi di rivestimento.

The sintered polystyrene foam is a non-toxic material, characterized by a high thermal insulation and a great resistance to humidity, perfect for the insulation of the Turkish bath. The EPS structure can be covered with mosaics or other types of coating.

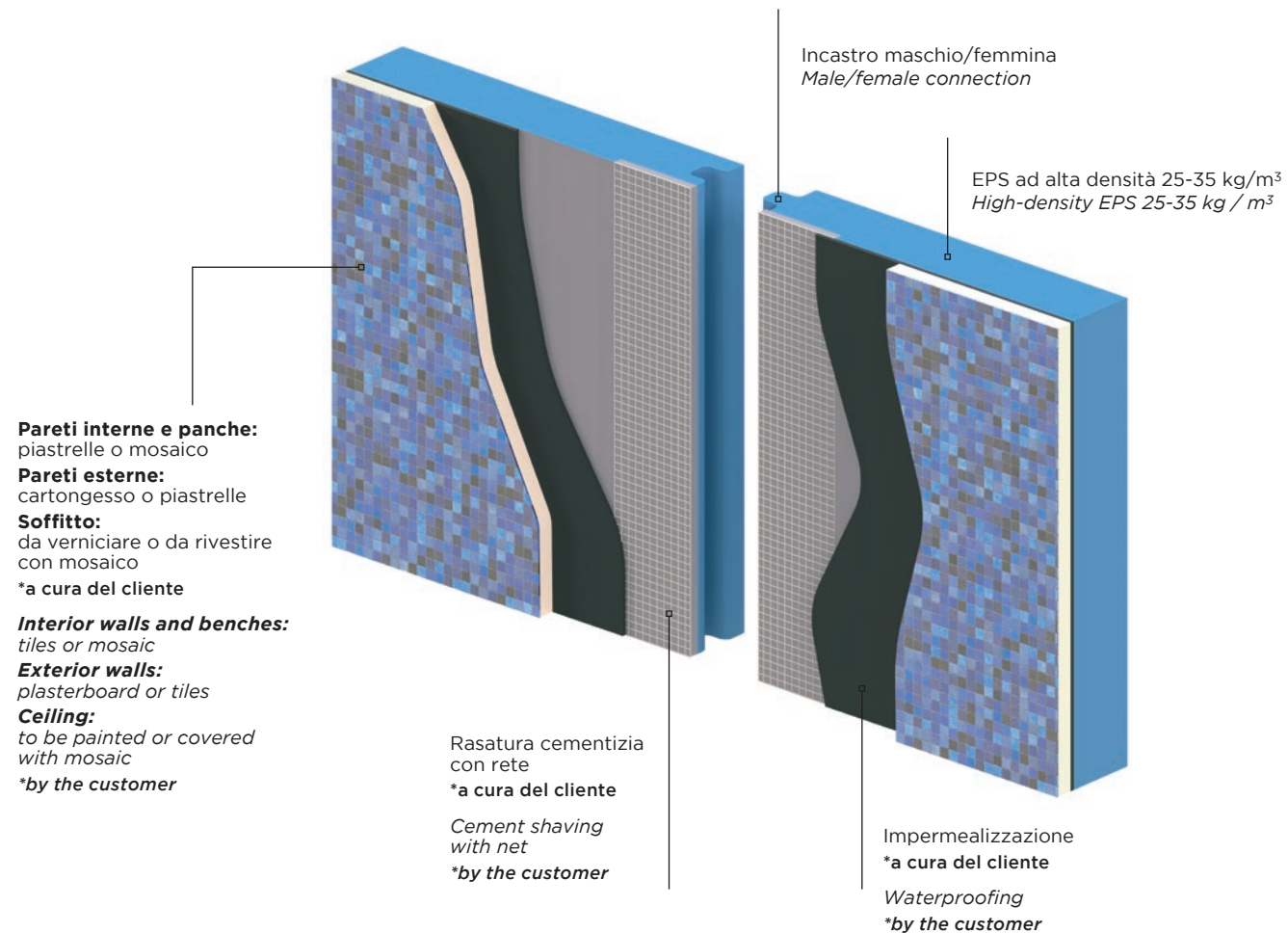

Hai uno spazio dove creare il tuo hammam?

Realizzalo con le nostre strutture coibentate e i generatori di vapore.

*Do you have a space to create your hammam?
Realize it with our insulated structures and steam generators.*

1

MISURA LO SPAZIO Measure the space

Individua lo spazio nell'ambiente bagno o in un'altra stanza dedicata dove poter realizzare il tuo angolo relax: c'è una soluzione adatta a tutte le misure.

Locate the space in the bathroom or another dedicated room where you can make your own relaxation corner: there is a solution suitable for all sizes.

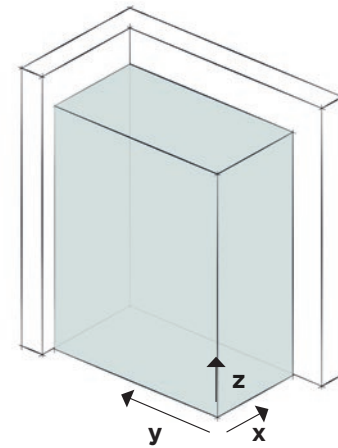

2

SCEGLI IL GENERATORE DI VAPORE Choose the steam generator

Ad incasso oppure all'esterno in un apposito vano tecnico, per grandi spazi o piccoli ambienti: scegli il modello più adatto alle tue esigenze.

Recessed or outside in a special technical compartment, for large spaces or small areas: choose the model that best suits your needs.

SV STEAM



SV STEAM MINI



SV STEAM PLUS



per grandi ambienti
for large environments

SV STEAM URUS



3

DEFINISCI TUTTE LE PARTI DELLA STRUTTURA Choose all parts of the structure

Pareti, soffitto, porta e rivestimenti: personalizza tutti gli elementi dell'hammam nelle misure, nelle finiture e anche nella funzionalità.

Walls, ceiling, door and coverings: customize all the elements of the hammam in the sizes, finishes and functionality.

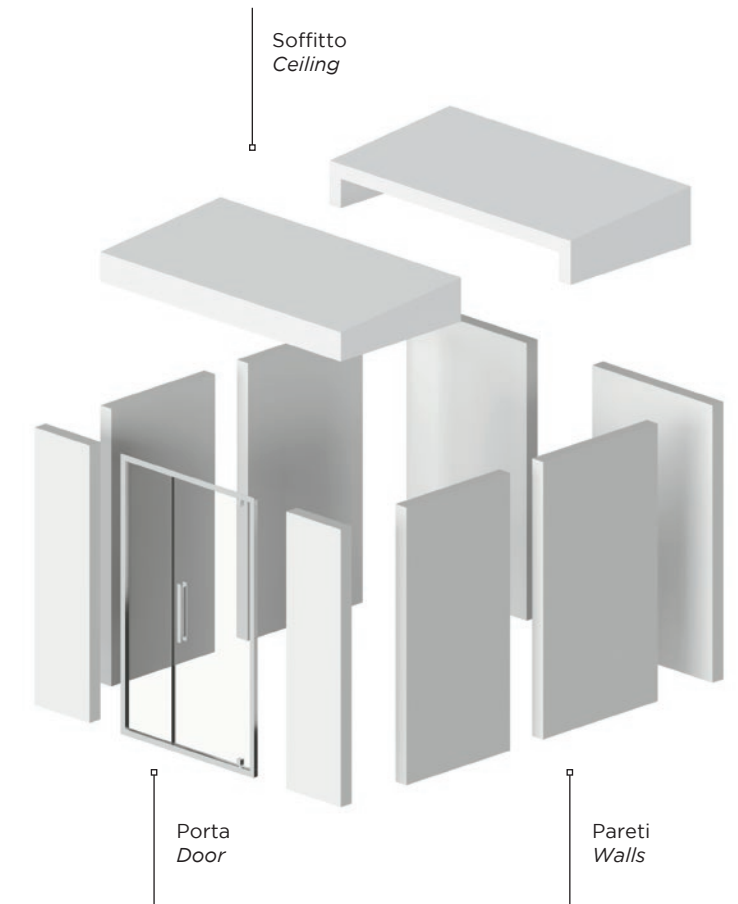

4

SCEGLI LA TIPOLOGIA DI SEDUTA Choose the type of sitting

Vedi pag. 189

See page 189

Con schienale o senza schienale, scegli la seduta ideale per il tuo spazio e la tua idea di comodità.

With back or without back choose the ideal seat for your space and your idea of comfort.

Seduta con schienale
Seat with backrestSeduta senza schienale
Seat without backrestSeduta curva
Curved seat

5

COMPLETA LO SPAZIO CON GLI ACCESSORI Complete the space with accessories

Vedi pag. 191

See page 191

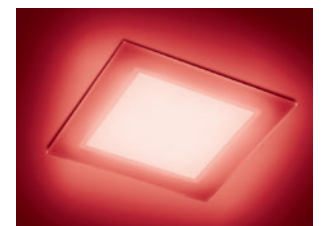

Touch screen LCD

Casse musica
Music speakersSoffione con cromoterapia
Shower head with colour therapyLuce e cromoterapia
Light and colour therapy

Modelli di generatori di vapore

Steam generator models



SV STEAM

DIMENSIONI

Installazione esterno muro
52x18x44 H
Potenza max: 12 kW
Installazione semincasso
mediante cassa in acciaio
52x9x44 H
Potenza max: 12 kW
kW 12 - max 12,5 m³
kW 10,5 - max 11 m³
kW 9 - max 9,5 m³
kW 7,5 - max 7,5 m³
kW 6 - max 6 m³
kW 5 - max 5 m³
kW 4 - max 4 m³

MEASUREMENT

Exterior wall installation
52x18x44 H
Max power: 12 kW
Semi built-in installation
via steel casing
52x9x44 H
Max power: 12 kW
kW 12 - max 12.5 m³
kW 10.5 - max 11 m³
kW 9 - max 9.5 m³
kW 7.5 - max 7.5 m³
kW 6 - max 6 m³
kW 5 - max 5 m³
kW 4 - max 4 m³

CARATTERISTICHE

Sistema di decalcificazione per caldaia
Erogatore vapore con dispenser per aromaterapia
Display programmazione settimanale a fasce orarie
Gestione di:
Luce-cromoterapia
Sistema audio
Programmazione settimanale
Ventilatore
USB / AUX
Predisposto per:
Pompe peristaltiche (2 aromi)

SPECIFICATIONS

Boiler descaling system
Steam dispenser with aromatherapy diffuser
Display weekly programming in time slots
Control of:
Light-chromotherapy
Sound system
Weekly programming
Fan
USB / AUX
Enables the installation of:
peristaltic pumps (2 aromas)

FINITURA

Bianco

FINISH

White

ESTERNO MURO

Exterior wall

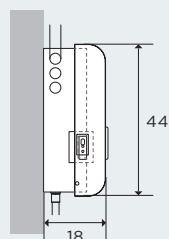

SEMINCASSO MURO

Semi built-in

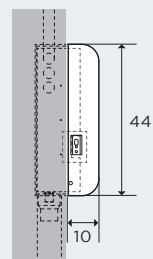

PARTICOLARI

Details



USB / AUX



Display

DIMENSIONI

58x13x31,5 H
Potenza max: 5 kW
kW 5 - max 5,5 m³
kW 4 - max 4,5 m³
kW 3 - max 3,5 m³

INSTALLAZIONE

Esterno muro

MEASUREMENT

58x13x31.5 H
Max power: 5 kW
kW 5 - max 5.5 m³
kW 4 - max 4.5 m³
kW 3 - max 3.5 m³

INSTALLATION

Exterior wall

ESTERNO MURO

Exterior wall

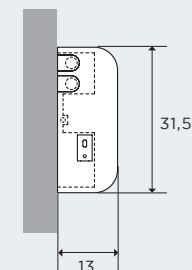

SV STEAM MINI

CARATTERISTICHE

Sistema di decalcificazione per caldaia
Erogatore vapore con dispenser per aromaterapia
Display
Gestione di:
Luce-cromoterapia
Sistema audio
Programmazione settimanale
USB / AUX

SPECIFICATIONS

Boiler descaling system
Steam dispenser with aromatherapy diffuser
Display
Control of:
Light-chromotherapy
Sound system
Weekly programming
USB / AUX

FINITURE

Bianco

FINISHING

White

PARTICOLARI

Details



USB / AUX



Display



SV STEAM URUS

DIMENSIONI

37x50x28 H
Potenza max: 12 kW
kW 4 - max 6 m³
kW 6 - max 9 m³
kW 9 - max 12 m³
kW 12 - max 18 m³

CARATTERISTICHE

Ideale per posizionamento su vani tecnici e a soffitto
Erogatore vapore con dispenser per aromaterapia
Display programmazione settimanale a fasce orarie
Gestione di:
Luce-cromoterapia
Sistema audio
Programmazione settimanale
Ventilatore
USB / AUX
Predisposto per:
Pompe peristaltiche (2 aromi)
Piedini regolabili per appoggio a soffitto

FINITURA

Acciaio Inox

MEASUREMENT

37x50x28 H
Max power: 48 kW
kW 4 - max 6 m³
kW 6 - max 9 m³
kW 9 - max 12 m³
kW 12 - max 18 m³

SPECIFICATIONS

Ideal for positioning on technical and ceiling areas
Steam dispenser with aromatherapy diffuser
Display weekly programming in time slots
Control of:
Light-chromotherapy
Sound system
Weekly programming
Fan
USB / AUX
Enables the installation of:
peristaltic pumps (2 aromas)
Adjustable feet for ceiling support

FINISH

Stainless steel

DIMENSIONI Measurement

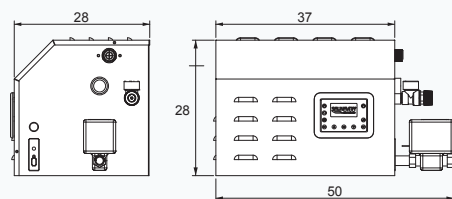

PARTICOLARI Details



Display

Generatore di vapore ad elettrodi immersi Immersed electrode steam generators



SV STEAM PLUS

DIMENSIONI

36,5x27,5x71,2 H
54,5x37,5x81,5 H
63,5x46,5x89 H
Potenza max: 48 kW
kW 14 - max 18 kg/h
kW 18 - max 25 kg/h
kW 26 - max 35 kg/h
kW 33 - max 45 kg/h
kW 48 - max 65 kg/h

CARATTERISTICHE

Display grafico remotabile
Gestione fasce orarie e temperature con programmazione giornaliera o settimanale sonda passiva di temperatura
Predisposto per:
La gestione essenze e ciclo di attivazione (fino a 3 essenze max)
Ciclo di sanificazione
Controllo di due ventilatori
On-off per la gestione della luce interna da display
Richiede la predisposizione di un vano tecnico

ACCESSORI

Kit remotazione terminale per umidificatori
Tubo vap. spiral. acc. D.= 30 mm
Kit uscita vapore UE 25-65 kg/H y + tubo
Distributore con foro cieco (2 pezzi)
Kit double check valve
Tubo gomma radio di 40x50 - 1 metro lineare
Modulo audio alimentato a 230V con ingresso USB-AUX e gestione cromoterapia con display LCD integrato
Disponibili casse audio + faro cromoterapia-luce

MEASUREMENT

36.5x27.5x71.2 H
54.5x37.5x81.5 H
63.5x46.5x89 H
Max power: 48 kW
kW 14 - max 18 kg/h
kW 18 - max 25 kg/h
kW 26 - max 35 kg/h
kW 33 - max 45 kg/h
kW 48 - max 65 kg/h

SPECIFICATIONS

Weekly or daily programming of time slots and temperature passive temperature sensor
Enables the installation of:
Essence management and activation cycle (up to 3 essences)
Sanitation cycle
Control of two fans
On-off management of the display interior light
It requires the preparation of a technical compartment

ACCESSORIES

Terminal remoting kit for humidifiers
Spiral steel steam tube D.= 30 mm
Steam outlet kit UE 25-65 kg/H y + tube
Dispenser with blind hold (2 pieces)
Double check valve kit
Rubber hose 40x50 radio 1 linear metre
230V sound system with USB-AUX input and chromotherapy with built-in LCD display
Speakers-chromotherapy light available

DIMENSIONI Measurement

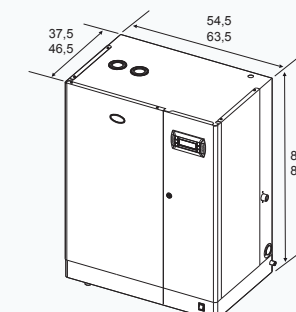
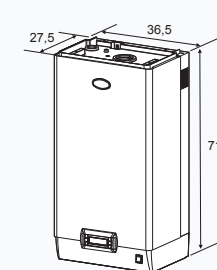

PARTICOLARI Details



Display

Tipologie di installazione

Steam generator models

Installazione SV STEAM su vani tecnici (esterno muro)

Ideale per l'utilizzo professionale. La gestione delle funzioni può essere controllata direttamente, con display a bordo del generatore di vapore, o in modalità remota tramite display LCD.

SV STEAM installation on technical compartments (exterior wall)

Wall installation is ideal for the professional use. Selection of functions can be managed directly through a LCD integrated display, or managed remotely.

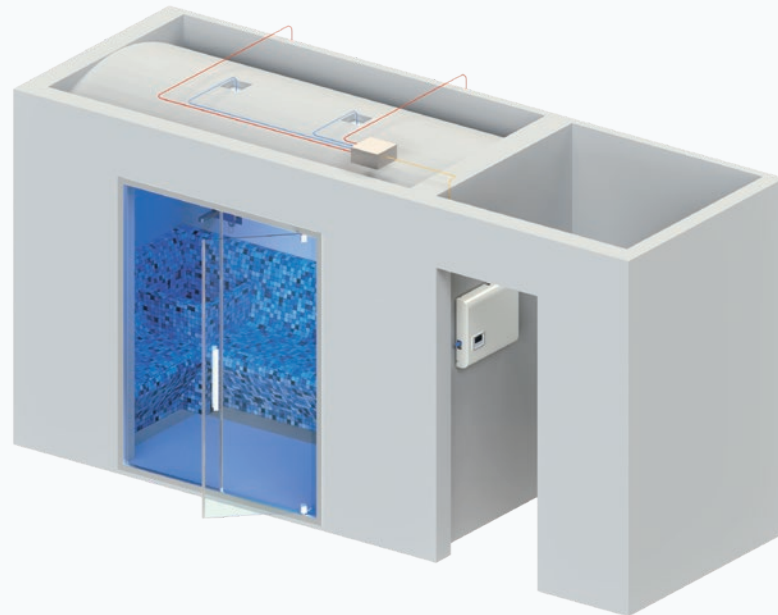

Installazione SV STEAM a vista (semi-incasso)

Il generatore a semi-incasso diventa elemento d'arredo, elegante e lineare. Il display LCD, posto all'interno dell'hammam, permette il controllo di tutte le funzioni. Ideale per l'utilizzo domestico.

SV STEAM installation (semirecessed)

Semi-encased steam generator becomes a design element, elegant and with clean style. LCD display enables to manage every function from the inside of the hammam.

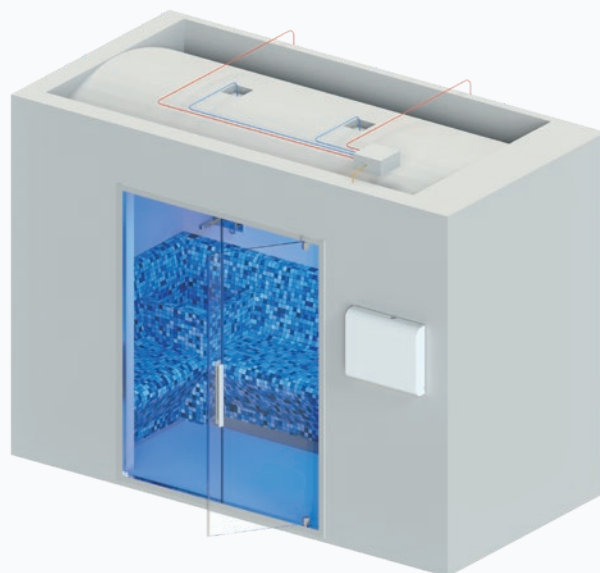

Installazione SV STEAM URUS per soffitto o vano tecnico

Dimensioni studiate per poterlo inserire in vani molto bassi grazie alla sua altezza di soli 28 cm.

SV STEAM URUS installation for ceiling or technical room

Dimensions are designed to be able to place the steam generator in very low rooms thanks to its height of only 28 cm.

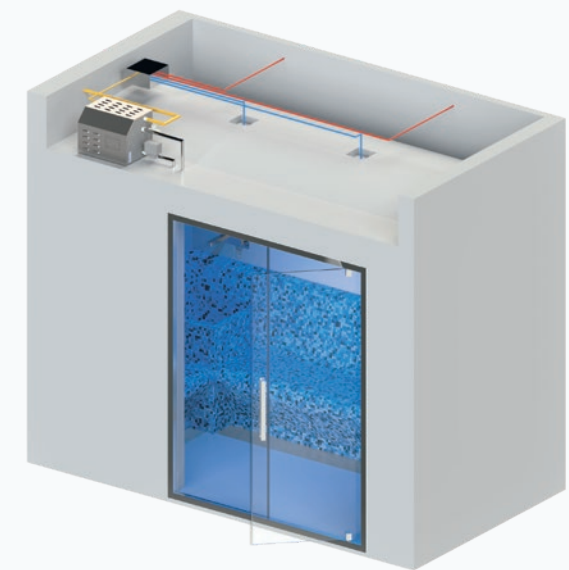

Installazione SV STEAM PLUS per grandi ambienti

Il generatore di vapore ha maggiori dimensioni e potenza per soddisfare ambienti voluminosi e garantire temperatura e umidità uniformi.

SV STEAM PLUS installation for large environments

Steam generator has greater dimensions and power to satisfy high volume areas to provide uniform temperature and humidity.

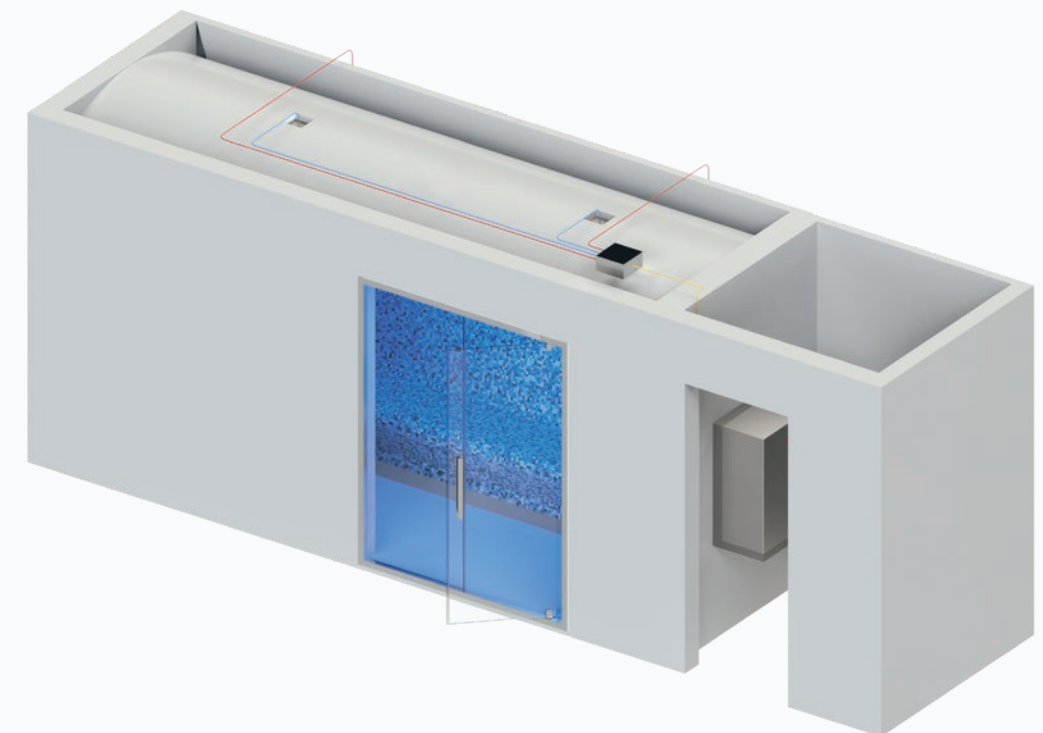

Strutture in eps rasato

Smooth EPS structures

ESEMPIO DI STRUTTURE

Lo spazio richiesto: Sv Steam è in grado di soddisfare tutti gli ambienti.

FRAMEWORK

Space needing: Steam generator suitable all the ambiences.

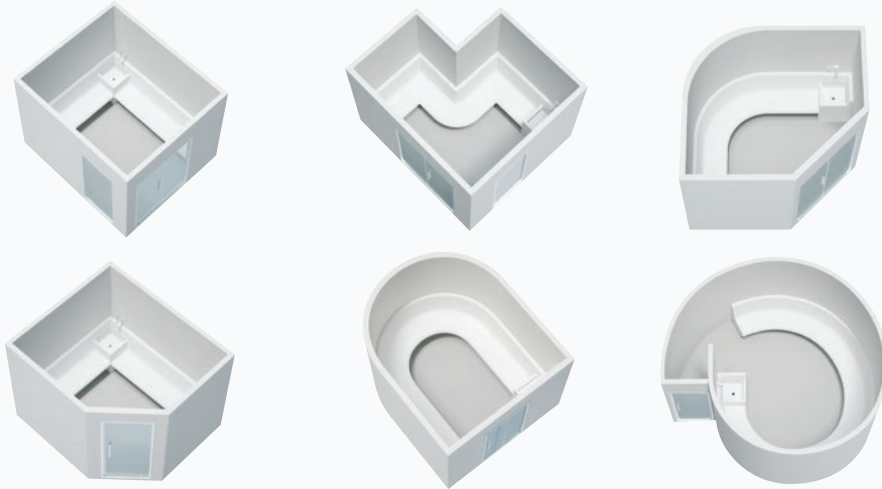

SOFFITTO

Evita l'effetto pioggia quando il vapore si condensa. Se la scelta ricade sul soffitto spiovente la pendenza deve essere almeno del 15%.

CEILING

These three shapes avoid the rain effect when steam condenses. In the case of the steep roof, the pitch should be at least 15%.



Volta a botte.
Barrel vaulted ceiling.

Soffitto inclinato.
Sloping ceiling.

Volta a crociera.
Cross vault ceiling.

SEDUTE

Sedute a muro rivestibili (su misura).

SEATS

Seats on wall coverable seat (custom made size).

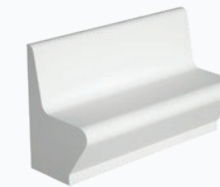

Seduta lineare con schienale.
Linear seat with backrest.

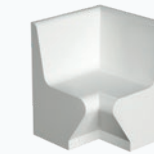

Seduta ad angolo con schienale.
Corner installation seat with backrest.



Seduta curva con schienale.
Curved seat with backrest.

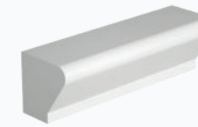

Seduta lineare senza schienale.
Linear seat without backrest.



Seduta ad angolo senza schienale.
Corner installation seat without backrest.



Seduta curva senza schienale.
Curved seat without backrest.



Seduta lineare con schienale.
Linear seat with backrest.



Seduta ad angolo con schienale.
Corner installation seat with backrest.



Angolo lavabo con schienale.
Sink with backrest.

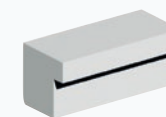

Seduta lineare senza schienale.
Linear seat without backrest.



Seduta ad angolo senza schienale.
Corner installation seat without backrest.



Angolo lavabo senza schienale.
Sink without backrest.



Erogatore di vapore.
Steam outlet.

Porte e vetrate con tenuta vapore

Steam seal doors and windows

MODELLO SV STEAM

Componenti fondamentali per garantire il corretto funzionamento del bagno di vapore. Le porte e gli elementi fissi, sono in cristallo temperato da 8 mm espressamente creati per assolvere la funzione di tenuta del vapore ed evitare l'entrata di aria fredda.

Disponibili su misura.

SV STEAM MODEL

Fundamental components to preserve the proper function of the Turkish bath. Doors and fixed elements, in crystal glass 8 mm thick are specially designed to perform steam keeping and avoid fresh air incoming.

Available custom made size.



Porta
Door



Porta con fisso
Door + fixed element



Elemento fisso
Fixed element



Porta senza profilo
Door without profile

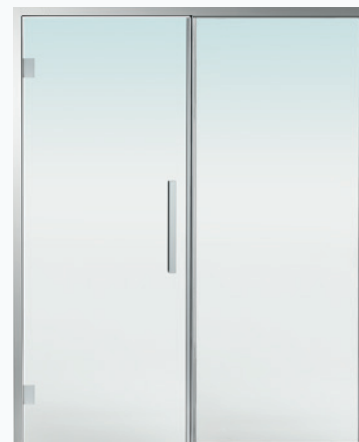

Porta con fisso senza profilo
Door + fixed element without profile



Elemento fisso senza profilo
Fixed element without profile

Accessori

Accessories

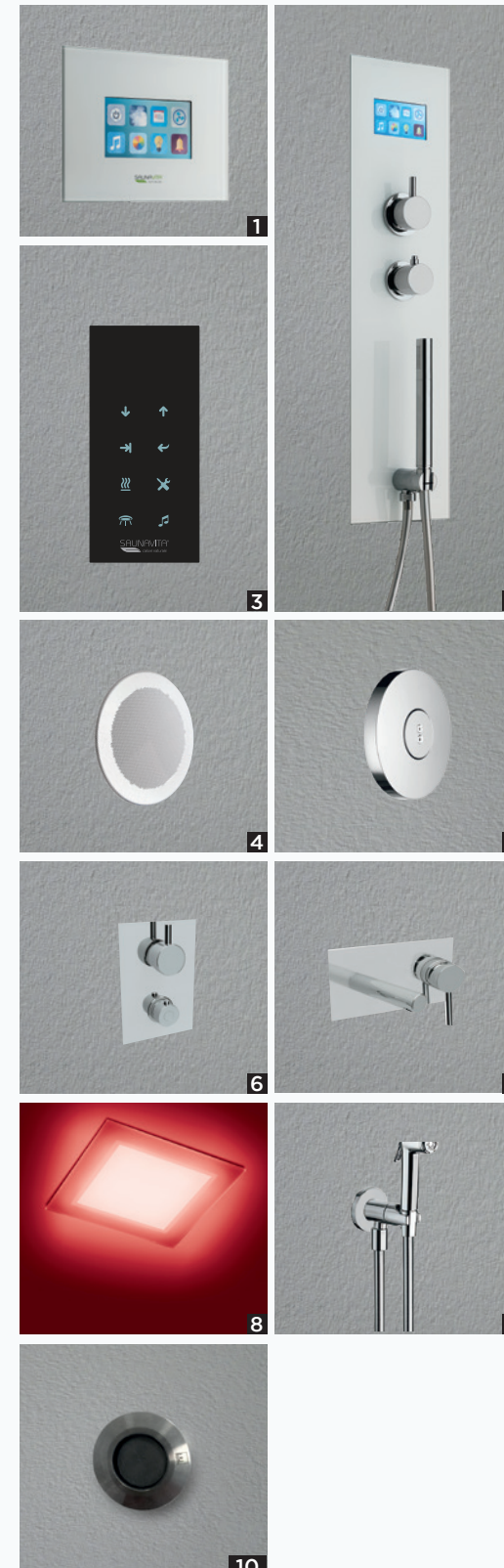

1. Tastiera Touch screen in cristallo con display LCD da 4.3" grafico a colori.
2. Tastiera Touch screen in cristallo con display LCD da 4.3" grafico a colori, completa di rubinetteria termostatica 3 vie e doccetta finitura cromo.
3. Tastiera capacitiva in cristallo nero con display Oled.
4. Sistema audio dotato di casse per la diffusione del suono e uscita USB per la connessione dei dispositivi audio.
5. Body Jet ad incasso in ABS cromato.
6. Miscelatore monocomando a 3 vie.
7. Miscelatore monocomando con bocca di erogazione.
8. Faro luce e cromoterapia in acciaio verniciato nero e cristallo.
9. Flessibile + doccino con rubinetto apertura/chiusura in finitura cromo.
10. Faretto ad incasso a LED luce bianca in acciaio Inox.
11. Soffione ad incasso in finitura acciaio.
12. Soffione con cromoterapia ad incasso in finitura acciaio.
13. Cascata lama ad incasso in finitura acciaio.

1. Crystal touch screen with color LCD display 4.3".
2. Crystal touch screen with color LCD display 4.3", with 3 ways thermostatic tap and handshower chrome finishing.
3. Black crystal touch screen with Oled display.
4. Sound system with speakers and USB output for the connection of audio devices.
5. Body Jet encased in ABS Chrome.
6. Single-lever 3-way mixer
7. Single-lever mixer with spout
8. Light and Chromotherapy light house in black and crystal painted steel.
9. Hose + Handheld shower head with opening/closing tap in chrome finish.
10. Encased white Light led spot in stainless steel.
11. Encased head-shower in steel finish.
12. Encased head-shower with chrome-therapy with steel finish.
13. Encased Water blade cascade in steel finishing.



HAMMAM

Generatori di vapore
Steam generator

Linea Rigenera ¹⁹⁶

Kit coibentazione ²¹⁴
Insulation kit

Porte e vetrate con tenuta vapore ²¹⁵
Steam seal doors and windows

G-Steam + Gemini ²¹⁸

Gemini ²²⁸

CONSIGLI PER L'HAMMAM

Turkish bath tips



Nell'Hamam si crea l'equilibrio perfetto tra calore e vapore per stimolare un'azione rilassante e depurativa sull'organismo. Il bagno turco risulta ancora più efficace quando è abbinato alla cromoterapia e all'aromaterapia.

Inside Hammam the perfect balance between heat and steam is created to stimulate a relaxing and purifying action on the body. The turkish bath is still there more effective when combined with chromotherapy and aromatherapy.

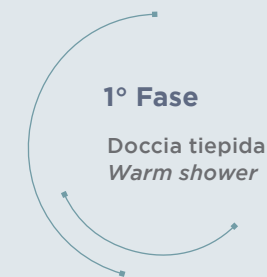

Prima di entrare fai una doccia tiepida e frizioni la pelle con un guanto di crine, per prepararla al calore. Puoi bere una tisana calda per favorire la sudorazione.

Take a warm shower first and rub your skin with a horsehair glove to prepare it for the heat. Drinking cup of hot herbal tea can promote transpiration.



Entra nel bagno turco nudo o coperto da un asciugamano e assumi una posizione comoda e rilassante. È consigliabile una permanenza tra i 10 e i 20 minuti.

Enter the Turkish bath naked or wrapped in a towel and take a comfortable and relaxing position. You can stay for 10 to 20 minutes.



Puoi aumentare i benefici dell'hammam diffondendo essenze per l'aromaterapia tramite l'erogatore di vapore e respirando a fondo e regolarmente.

You can enhance the benefits of a Turkish bath by diffusing aromatherapy essences and breathing in deeply and regularly.



Una volta uscito dall'hammam, fai una doccia fresca, asciugati e rimani sdraiato per almeno 20 minuti. Ricordati di bere dell'acqua per reintegrare i liquidi persi con la sudorazione.

After the Turkish bath, take a cool shower, dry yourself up, and lie down for at least 20 minutes. You will lose lots of fluid through transpiration, so make sure to drink plenty of water.

LINEA RIGENERA

collection

Un concentrato di tecnologia e design d'avanguardia caratterizzano la linea Rigenera. Essenziale colonna multifunzione con generatore di vapore per bagno turco.

A combination of technology and innovative design characterize the line Rigenera. Essential multifunction column with steam generator and turkish bath.

Cura estetica ed attenzione alla funzionalità hanno dato vita a Rigenera.

Aesthetic care and attention to functionality gave origin to our steam column Rigenera.



Rigenera²⁰⁰

Incasso in Cristallo
Built-in glass

LINEA RIGENERA | collection

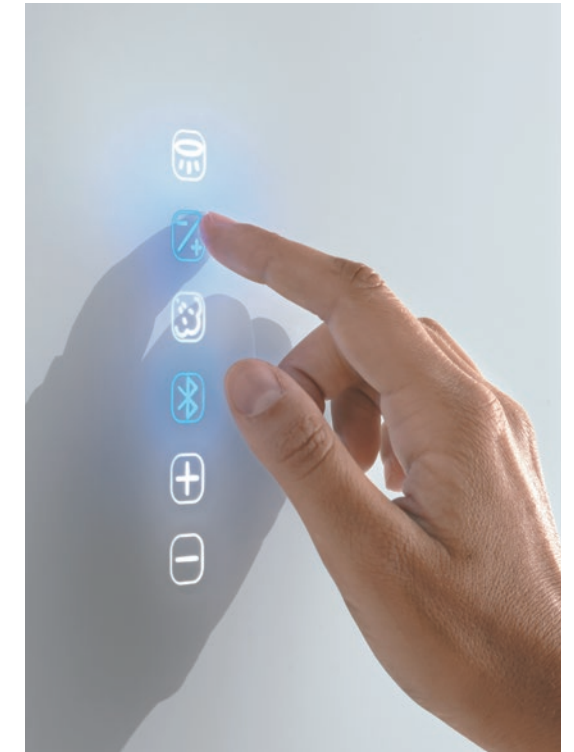

La tastiera, integrata nel cristallo, gestisce tutte le funzioni: bagno turco, cromoterapia e sistema audio con bluetooth.

Thanks to built in crystal glass keyboard it's possible to control every function: steam generator, colour therapy and bluetooth.

Erogatore di vapore con aromaterapia
Steam dispenser with aromatherapy



Un erogatore in acciaio alla base della colonna diffonde vapore nella cabina doccia, trasformandola in un bagno turco.

Steel dispenser at the base of the column spreads steam into the shower cubicle, turning it into a Turkish bath.

Rigenera 200 S

Incasso in Cristallo senza rubinetteria
Built-in glass without tap



Rigenera 200

Incasso in solid surface
Built-in solid surface



Rigenera 200

Esterna Solid Surface con soffione
External Solid Surface with shower head



Rigenera 200

Esterna Solid Surface senza soffione
External Solid Surface without shower head



Rigenera ⁷⁰

Mini lavabo, fonte d'acqua, generatore di vapore, luce e dispenser aromi: tutto il necessario per un perfetto bagno turco in un unico mobiletto.

Steam generator, light and aroma dispenser small washbasin and water source: whatever you need for a perfect Turkish bath in one single piece of furniture.



Il telecomando controlla tutte le funzioni, compresa la frequenza e il volume della radio.

Remote controls all functions, including the frequency and volume of the radio.



Rigenera + Gemini

Grazie a Gemini è possibile progettare ambienti per il bagno turco con dimensioni fino a 190x120 cm (h. 214 cm). Le pareti con cristallo temperato da 8 mm. Il tetto coibentato è disponibile in più varianti:

- con o senza soffione;
- con soffione e cromoterapia;

Gemini può essere installato con tutti i piatti doccia Hafro, o direttamente sul pavimento. Con un unico prodotto potrai avere una stanza hammam di immediato utilizzo senza opere di muratura ed economicamente vantaggiosa. Gemini si combina perfettamente con qualsiasi generatore di vapore.

Thanks to Gemini it's possible to set your own hammam in your house, it could measure up to 190x120 cm.

Crystal glass wall it's 8 mm thick.

The Insulation roof is available in several variants:

- with or without a shower head;

- with a shower head and chromotherapy;

Head shower is built into the roof. Gemini could be fitted on every Hafro shower tray or on the floor.



Rigenera 200

Incasso in cristallo
Built-in Rigenera 200 glass



Cromoterapia
Chromotherapy

Doccetta raining
"Raining" hand shower

Miscelatore termostatico
Thermostatic tap

Potenza generatore di vapore: 3-4-5-6 kW,
consente di allestire Hammam fino a 6,5 m³
*Steam generator power: 3-4-5-6 kW,
means Hammam till 6.5 m³*

Sistema audio con Bluetooth
Bluetooth Sound System

Erogatore di vapore
Steam dispenser

DIMENSIONI

38x10,2x198 H
kW 6 - max 6,5 m³
kW 5 - max 5,5 m³
kW 4 - max 4,5 m³
kW 3 - max 3,5 m³

CARATTERISTICHE

Generatore di vapore per bagno turco multiclimate
Sistema di decalcificazione per caldaia
Miscelatore termostatico a 3 vie (di cui 1 disponibile per eventuale accessorio soffione)
Doccetta raining
Erogatore vapore con dispenser per aromaterapia
Cromoterapia
Materiale di costruzione: acciaio satinato e frontale in Cristallo bianco

INSTALLAZIONE

Incasso

ACCESSORI

Audio con Bluetooth

MEASUREMENT

38x10.2x198 H
kW 6 - max 6.5 m³
kW 5 - max 5.5 m³
kW 4 - max 4.5 m³
kW 3 - max 3.5 m³

SPECIFICATIONS

Steam generator for Multiclimate Turkish baths
Boiler descaling system
3-way thermostatic mixer (of which 1 available for optional shower head accessory)
Rainfall handheld shower head
Steam dispenser with aromatherapy diffuser
Chromotherapy
Construction material: satin steel with white glass front

INSTALLATION

Built-in

ACCESSORIES

Sound with Bluetooth

Rigenera 200 S

Incasso in cristallo senza rubinetteria
Built-in rigenera 200 s glass without tap

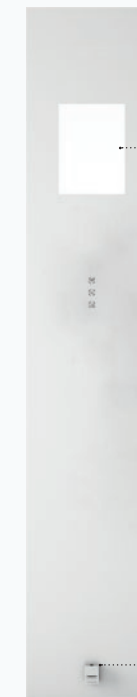

Cromoterapia
Chromotherapy

Potenza generatore di vapore: 3-4-5-6 kW,
consente di allestire Hammam fino a 6,5 m³
*Steam generator power: 3-4-5-6 kW,
means Hammam till 6.5 m³*

Sistema audio con Bluetooth
Bluetooth Sound System

Erogatore di vapore
Steam dispenser

DIMENSIONI

38x10,2x198 H
kW 6 - max 6,5 m³
kW 5 - max 5,5 m³
kW 4 - max 4,5 m³
kW 3 - max 3,5 m³

CARATTERISTICHE

Generatore di vapore per bagno turco multiclimate
Sistema di decalcificazione per caldaia
Erogatore vapore con dispenser per aromaterapia
Cromoterapia
Materiale di costruzione: acciaio satinato e frontale in Cristallo bianco

INSTALLAZIONE

Incasso

ACCESSORI

Audio con Bluetooth

MEASUREMENT

38x10.2x198 H
kW 6 - max 6.5 m³
kW 5 - max 5.5 m³
kW 4 - max 4.5 m³
kW 3 - max 3.5 m³

SPECIFICATIONS

Steam generator for Multiclimate Turkish baths
Boiler descaling system
Steam dispenser with aromatherapy diffuser
Chromotherapy
Construction material: satin steel with white glass front

INSTALLATION

Built-in

ACCESSORIES

Sound with Bluetooth

Rigenera 200

Incasso in Solid Surface
Built-in Rigenera 200 Solid Surface

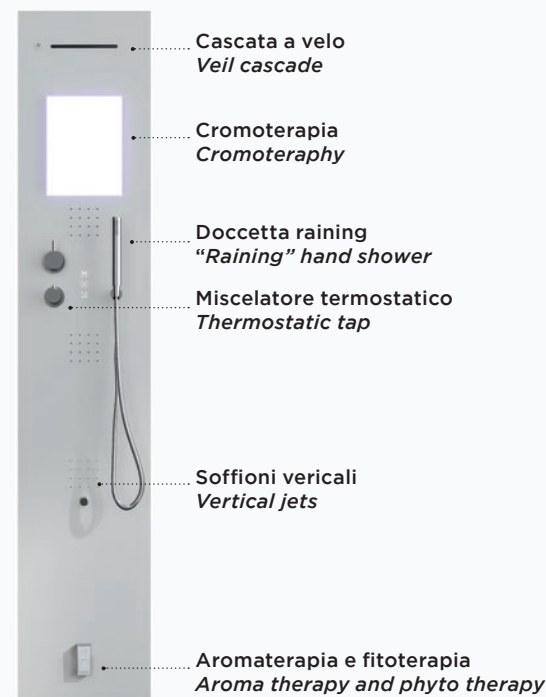

DIMENSIONI

38x10,2x198 H
kW 4 - max 4,5 m³
kW 3 - max 3,5 m³

CARATTERISTICHE

Generatore di vapore per bagno turco multiclimate
Sistema di decalcificazione per caldaia
Miscelatore termostatico a 5 vie (di cui 1 disponibile per eventuale accessorio soffione)
Doccetta raining
Cascata a velo
Nr. 3 soffioni verticali
Erogatore vapore con dispenser per aromaterapia
Cromoterapia
Materiale di costruzione: acciaio satinato e frontale in Solid Surface

INSTALLAZIONE

Incasso

MEASUREMENT

38x10.2x198 H
kW 4 - max 4.5 m³
kW 3 - max 3.5 m³

SPECIFICATIONS

Steam generator for Multiclimate Turkish baths
Boiler descaling system
5-way thermostatic mixer (of which 1 available for optional shower head accessory)
Rainfall handheld shower head
Water blade cascade
3 vertical jets
Steam dispenser with aromatherapy diffuser
Chromotherapy
Construction material: satin steel with Solid Surface front

INSTALLATION

Built-in

Rigenera 200

Solid Surface senza soffione
Solid Surface without shower head

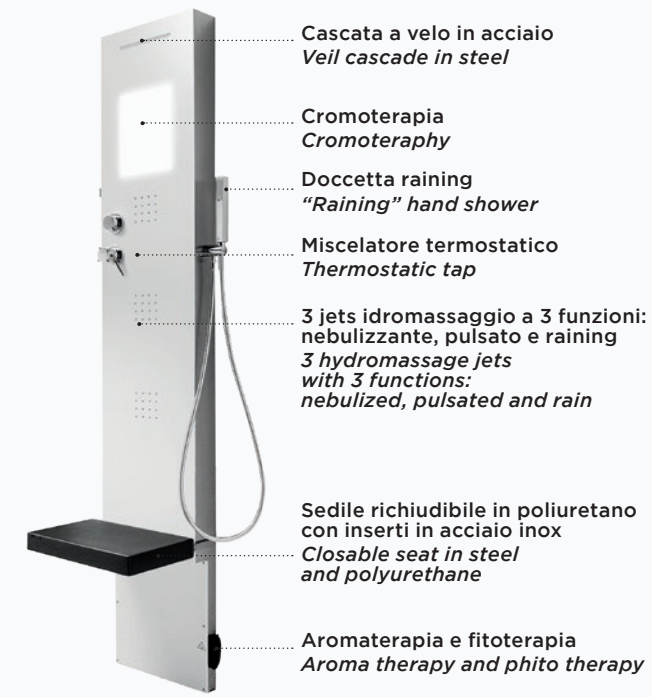

DIMENSIONI

35x11x199 H
kW 4 - max 4,5 m³
kW 3 - max 3,5 m³

CARATTERISTICHE

Generatore di vapore da 3/4 kW per bagno turco multiclimate
Sistema di decalcificazione per caldaia
Miscelatore termostatico (di cui 1 disponibile per eventuale accessorio soffione)
Doccetta
Cascata a velo
Nr. 3 soffioni verticali
Sedile richiudibile in acciaio e poliuretano - colore Antracite
Erogatore vapore con dispenser per aromaterapia e fitoterapia
Cromoterapia
Tastiera touch
Materiale di costruzione: acciaio satinato e frontale in Solid Surface

FINITURA

Solid Surface

MEASUREMENT

35x11x199 H
kW 4 - max 4.5 m³
kW 3 - max 3.5 m³

SPECIFICATIONS

4 kW steam generator for Multiclimate Turkish baths
Boiler descaling system
Thermostatic mixer (of which 1 available for optional shower head accessory)
Handheld shower head
Water blade cascade
3 vertical jets
Steel and polyurethane foldable seat - Antracite colour
Steam dispenser with aromatherapy and phytotherapy diffuser
Chromotherapy
Touch keypad
Construction material: satin steel with Solid Surface front

FINISH

Solid Surface

Rigenera 200

Solid Surface con soffione
Solid Surface with shower head

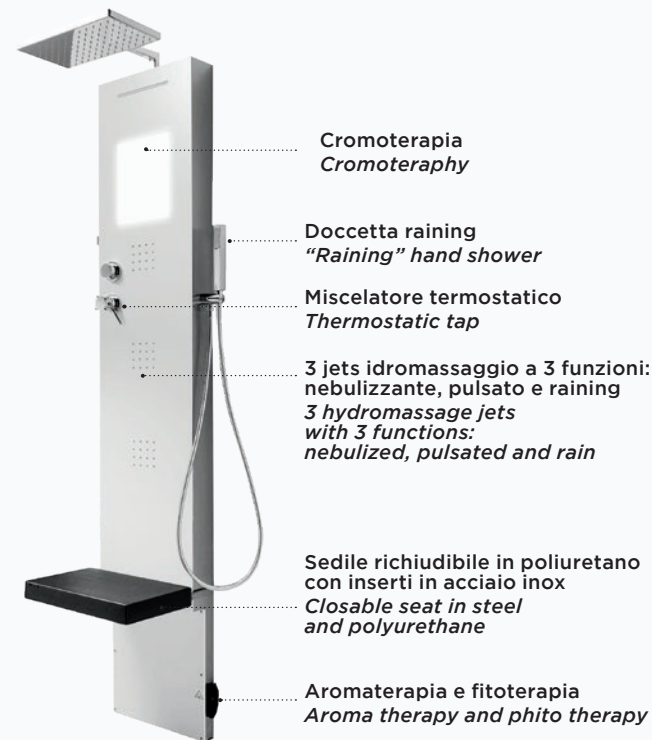

Cromoterapia
Chromotherapy

Doccetta raining
"Raining" hand shower

Miscelatore termostatico
Thermostatic tap

3 jets idromassaggio a 3 funzioni:
nebulizzante, pulsato e raining
*3 hydromassage jets
with 3 functions:
nebulized, pulsated and rain*

Sedile richiudibile in poliuretano
con inserti in acciaio inox
*Closable seat in steel
and polyurethane*

Aromaterapia e fitoterapia
Aroma therapy and phito therapy

DIMENSIONI

35x11x199 H
kW 4 - max 4,5 m³
kW 3 - max 3,5 m³

CARATTERISTICHE

Generatore di vapore da 3/4 kW
per bagno turco multiclimate
Sistema di decalcificazione per caldaia
Miscelatore termostatico 5 vie
Doccetta
Cascata a velo
Nr. 3 soffioni verticali
Sedile richiudibile in acciaio e
poliuretano - colore Antracite
Erogatore vapore con dispenser
per aromaterapia e fitoterapia
Cromoterapia
Tastiera touch
Materiale di costruzione: acciaio satinato
e frontale in Solid Surface

FINITURA

Solid Surface

MEASUREMENT

35x11x199 H
kW 4 - max 4.5 m³
kW 3 - max 3.5 m³

SPECIFICATIONS

3/4 kW steam generator for Multiclimate
Turkish baths
Boiler descaling system
5-way thermostatic mixer
Handheld shower head
Water blade cascade
3 vertical jets
Steel and polyurethane foldable seat -
Antracite colour
Steam dispenser with aromatherapy
and phytotherapy diffuser
Chromotherapy
Touch keypad
Construction material: satin steel
with Solid Surface front

FINISH

Solid Surface

Rigenera 70

Solid Surface

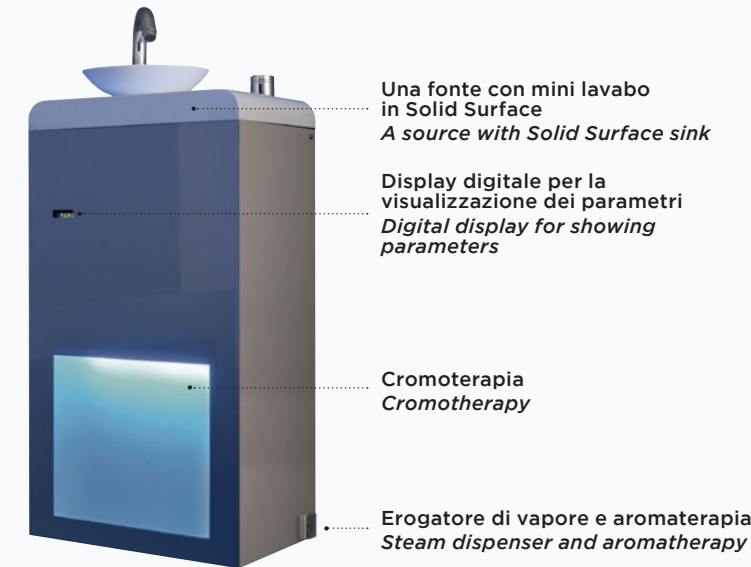

Una fonte con mini lavabo
in Solid Surface
A source with Solid Surface sink

Display digitale per la
visualizzazione dei parametri
*Digital display for showing
parameters*

Cromoterapia
Chromotherapy

Erogatore di vapore e aromaterapia
Steam dispenser and aromatherapy



Il telecomando controlla
tutte le funzioni, la frequenza,
il volume della radio,
la temperatura e la durata
del bagno turco.
*The remote controls all the
functions, the frequency,
the volume of the radio, the
temperature and the duration
of the turkish bath.*

DIMENSIONI

40,5x26x73 H
kW 6 - max 6,5 m³
kW 5 - max 5,5 m³
kW 4 - max 4,5 m³

CARATTERISTICHE

Generatore di vapore
Manutenzione caldaia programmata
Sistema di decalcificazione per caldaia
Erogatore vapore con dispenser
per aromaterapia e fitoterapia
Ciotolina in Solid Surface
Cromoterapia
Radio
Display
Telecomando per controllo funzioni e
temperatura
Fonte acqua fresca

FINITURE LUCIDE

Bianco
Nero
Cappuccino

MEASUREMENT

40.5x26x73 H
kW 6 - max 6.5 m³
kW 5 - max 5.5 m³
kW 4 - max 4.5 m³

SPECIFICATIONS

Steam generator
Scheduled boiler maintenance
Boiler descaling system
Steam dispenser with aromatherapy
and phytotherapy diffuser
Solid Surface bowl
Chromotherapy
Radio
Display
Function and temperature remote
control
Fresh water source

POLISHED FINISHES

White
Black
Cappuccino

Kit coibentazione

Insulation kit

LA COIBENTAZIONE: PIÙ RESA, MENO CONSUMI

Coibentare le pareti ed il soffitto del vano assicura una resa migliore ed un minor consumo di energia, evitando dispersione di calore.

Hafro comprende un kit di pannelli completamente isolanti da 60x125 cm, spessi 3 cm, rivestiti in malta cementizia. Il rivestimento di finitura, mosaico o piastrelle, e le eventuali opere in muratura o cartongesso richieste, rientrano nell'ambito della personalizzazione dell'ambiente.

Kit coibentazione con:

- pannelli isolanti da 60x125 cm
- finitura per ricoprire: mosaico o piastrelle.

THE INSULATION: GREATER PERFORMANCE, LOWER CONSUMPTION

Insulating the walls and the ceiling of the room ensures greater output and lower energy consumption, by avoiding heat dispersal.

Hafro includes a kit of 60x125 cm, 3 cm thick panels, which insulate completely and are covered in cement mortar. Their finishings, in mosaic or tiles, and any brickwork or plasterboarding can be freely personalised by the client.

Insulation kit with:

- insulating panels 60x125 cms
- finish to cover: mosaic or tiles.

LO SPAZIO RICHIESTO

Lunghezza e larghezza possono variare, sapendo che un generatore di vapore a seconda della potenza può soddisfare ambienti di volumi differenti.

Il flusso di vapore sarà così sempre bilanciato, con temperatura e umidità uniformi.

SPACE NEEDING

Length and width may vary, steam generator selection can satisfy space of different volumes. Steam will always be equalized, temperature and damp will always be uniform.

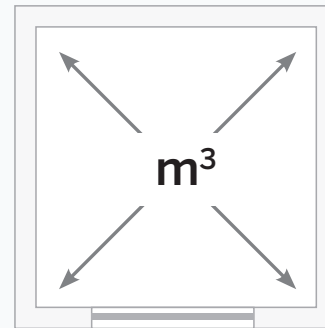

Porte e vetrate con tenuta vapore

Steam seal doors and windows

PORTE E VETRATE

Sono un elemento fondamentale perché devono evitare nella maniera più assoluta l'entrata d'aria e la fuoriuscita di vapore, assicurando così un perfetto isolamento dell'ambiente.

Porte e vetrate, in cristallo temperato da 6 mm, sono state realizzate espressamente per questa funzione, con un design essenziale e pulito che ne facilita l'inserimento in ogni tipo di locale.

Disponibili su misura.

DOOR AND WINDOWS

These are fundamental element since they prevent air from getting in and steam from getting out, therefore completing the insulation of the room. 6 mm tempered glass doors and panels have been designed specifically to this purpose, with an essential and clean design, which enables them to be easily matched with all types of bathroom.

Available custom made size.

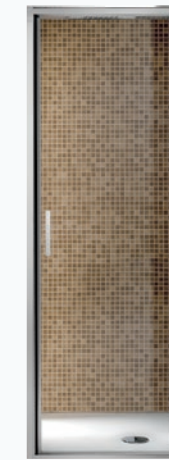

Porta singola (68 min / 72 max cm)

Di facile e sicuro montaggio, esteticamente piacevole, con eleganti profili in acciaio, maniglia sagomata e una larghezza che può variare da 68 a 72 cm.

Single door (68 min / 72 max cm)

This is the simplest way to create a functional entrance in technical terms, which is easy and safe to assemble and is aesthetically pleasing, with elegant profiles made of stainless steel, a shaped handle and widths that can vary from 68 to 72 cm.



Lato fisso (68 min / 72 max cm)

Le stesse caratteristiche fisiche e lo stesso design della porta si ritrovano nel lato fisso da aggiungere, una parete vetrata perfettamente isolante che allarga il senso dello spazio e dà all'ambiente un respiro maggiore.

Fixed sidewalls (68 min / 72 max cm)

The same physical characteristics and the same design as the door are to be found in the fixed sidewall, a perfectly insulating glass panel that enlarges the sense of space and gives the setting greater breathing space.

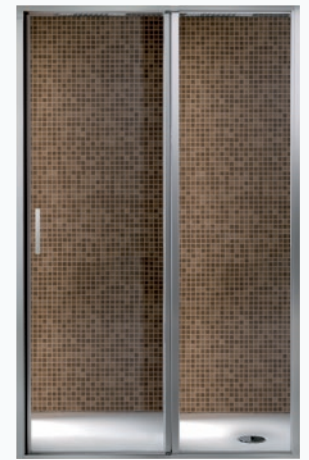

Vetrata (0 min / 80-100-110-120 max cm)

Nei bagni turchi di volume più grande, l'utilizzo della vetrata isolante, realizzata con gli stessi criteri tecnici ed estetici della porta, offre una variante progettuale di grande interesse, dando la possibilità di creare un bagno turco con pareti trasparenti.

Glass door (0 min / 80-100-110-120 max cm)

In the larger-sized Turkish baths, the use of insulating glass doors made with the same technical and aesthetic criteria as the door offers a very interesting planning variant, offering the possibility of creating a Turkish bath with transparent walls.

Accessori

Accessories

LAVANDINI

Per completare l'arredamento dell'ambiente si può installare un piccolo e grazioso lavamani in Solid Surface, bianco o nero, completo di miscelatore, sifone e piletta, per avere sempre a disposizione una gradevole fonte d'acqua fresca. La forma può essere semicircolare o rettangolare.

WASHBASIN

To complete the setting, a small and stylish Solid Surface basin, white or black, can be installed equipped with a mixer, siphon and plug, to get a refreshing supply of water at any time. It can be semi-circular or rectangular.



SOFFIONI

Soffioni ad incasso con controcassa in finitura acciaio.

SHOWER HEADS

Built-in shower heads with second steel casing.



Soffione ad incasso
Built-in shower head
30x30 / 38x38 cm

Soffione ad incasso
con cromoterapia
Built-in shower head
with chromotherapy
38x38 cm

PANCHE E ACCESSORI

1. Seduta a muro ribaltabile 36x30x8 H.
2. Sgabello in acrilico 40x24,5x44 H.
3. Sgabello in acciaio e Corian® 38x27,8x44 H.
4. Sgabelli in Solid Surface bianco 42x25x44 H e 37,5x25x41,5 H.
5. Panca 100x34x45 H.
6. Sgabello 45x34x45 H.
7. Luce e cromoterapia.
8. Miscelatore monocomando con bocca di erogazione.
9. Miscelatore monocomando a 3 vie.

BENCHES AND ACCESSORIES

1. Wall-mount folding seat 36x30x8 H.
2. Acrylic stool 40x24.5x44 H.
3. Steel and Corian® stool 38x27.8x44 H.
4. Solid surface stool 42x25x44 H and 37.5x25x41.5 H.
5. Bench 100x34x45 H.
6. Stool 45x34x45 H.
7. Chromotherapy and light.
8. Single lever mixer tap with spout.
9. Three-way single lever mixer tap.



G-STEAM+ GEMINI

collection

G-Steam è il prodotto ideale per chi vuole realizzare un hammam all'interno del proprio bagno senza eseguire lavori di muratura. La colonna può essere abbinata unicamente al box doccia Gemini con chiusura battente, scorrevole o pivotante e con uno spessore di soli 3,8 cm non necessita di incasso nel muro. Il programma G-Steam+Gemini unisce design, tecnologia e funzionalità in un unico prodotto.

G-Steam is the ideal product for those who want to place hammam inside their bathroom without performing masonry work. The column can only be matched to the Gemini shower cubicle with hinged, sliding or pivoting doors and thanks to its thickness of only 3.8 cm it does not need to be recessed into the wall. The G-Steam + Gemini program combines design, technology and functionality in a single product.

**La nuova colonna doccia con
generatore di vapore abbinabile
al box doccia Gemini.**

*The new shower column with
steam generator can be matched with
the Gemini shower box.*



Generatore di vapore G-Steam

G-Steam generator



G-STEAM



Box doccia Gemini

Gemini shower box

Gemini 5 scorrevole
sliding doorsGemini 5 battente
hinged doorsGemini 5 pivottante
pivoting doors

Piatti doccia (catalogo shower)

Shower trays (shower catalogue)

Modelli G-Steam

G-Steam models

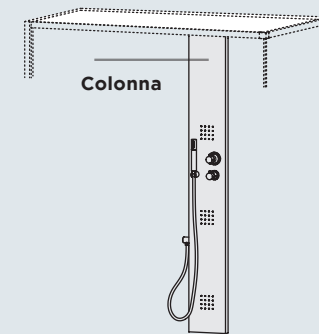

G-steam^{BASE}

Colonna doccia in acciaio completa di 3 body jet, rubinetteria termostatica e doccia.

Base steel shower column complete with 3 body jets, thermostatic taps and handheld shower head.

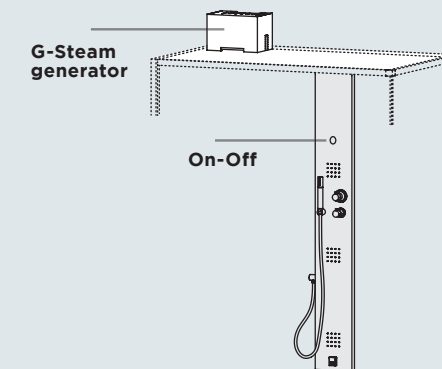

G-steam^{ON - OFF}

Unisce alla colonna doccia il generatore di vapore per bagno turco, da posizionare sopra il tetto della cabina doccia, e un semplice comando meccanico on/off per l'accensione/spengimento del generatore di vapore.

On/Off combines a Turkish bath steam generator to the shower column, to be positioned over the shower cubicle roof, with a simple mechanical on/off control to activate/deactivate the steam generator.

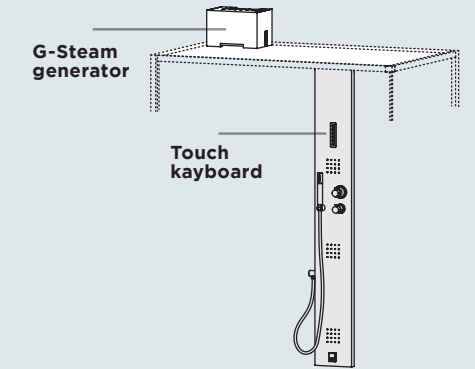

G-steam^{TOP}

Unisce alla colonna doccia il generatore di vapore per bagno turco multiclimate, con comandi a tastiera digitale touch, sensore di temperatura e possibilità di installare il sistema per la cromoterapia e l'accessorio Bluetooth.

Top combines a Multiclimate system Turkish bath steam generator to the shower column, with digital touch keypad controls, temperature sensor and the possibility of installing a colour therapy system and Bluetooth accessory.

Plus



Senza opere murarie
No masonry works



Pronto all'uso
Ready to use



Salva spazio
Space saving



G Steam^{TOP} + Gemini

CARATTERISTICHE

Gemini 5 scorrevole SX 160x100 cm
soffione 30x30 cm con cromoterapia
colonna G-Steamm Top
piatto Forma H. 3, 160x100 cm Antracite
seduta ribaltabile bianca (pz. 2)

SPECIFICATIONS

Gemini 5 sliding 160x100 cm left
30x30 cm shower head accessory
with colour therapy
G-Steamm Top column
Forma H. 3 tray, 160x100 cm Anthracite
White folding seat (2-pc.)

G-steam TOP



G-steam BASE



G-steam ON - OFF



**Generatore ed erogatore di vapore
solo per versione G-Steam Top e On-Off**
*Steam generator only for
G-Steam Top and On-Off versions*



G Steam ^{BASE}



G-Steam Base colonna doccia

DIMENSIONI
24x3,8x190 H cm

CARATTERISTICHE
Miscelatore termostatico a 3 vie (di cui 1 disponibile per soffione posizionato nel tetto)
Doccetta
3 soffioni verticali
Materiale di costruzione acciaio inox lucido

G-Steam Base shower column

MEASUREMENT
24x3.8x190 H cm

SPECIFICATIONS
3-way thermostatic mixer (of which 1 for the shower head positioned on the roof)
Handheld shower head
3 vertical jets
Satin stainless steel construction material



Colonna doccia con generatore di vapore

DIMENSIONI
24x3,8x190 H cm
4 kW - 4,5 m³
3 kW - 3,5 m³
2,5 kW - 3 m³

Materiale di costruzione acciaio inox lucido

CARATTERISTICHE
Miscelatore termostatico a 3 vie (di cui 1 disponibile per soffione posizionato nel tetto)
Doccetta
3 soffioni verticali
Erogatore di vapore in acciaio inox, con aromaterapia
Generatore di vapore (da posizionare sopra il tetto) con cover di copertura
Comando meccanico (on/off) per attivazione e spegnimento bagno turco

Shower column with steam generator

MEASUREMENT
24x3,8x190 H cm
4 kW - 4,5 m³
3 kW - 3,5 m³
2,5 kW - 3 m³

Materiale di costruzione acciaio inox lucido

SPECIFICATIONS
Miscelatore termostatico a 3 vie (di cui 1 disponibile per soffione posizionato nel tetto)
Doccetta
3 soffioni verticali
Erogatore di vapore in acciaio inox, con aromaterapia
Generatore di vapore (da posizionare sopra il tetto) con cover di copertura
Comando meccanico (on/off) per attivazione e spegnimento bagno turco

G Steam ^{ON-OFF}

G Steam ^{TOP}



Colonna con generatore di vapore e cromoterapia

DIMENSIONI
24x3,8x190 H cm
4 kW - 4,5 m³
3 kW - 3,5 m³
2,5 kW - 3 m³

Materiale di costruzione acciaio inox lucido

CARATTERISTICHE
Miscelatore termostatico a 3 vie (di cui 1 disponibile per soffione posizionato nel tetto)
Doccetta
3 soffioni verticali
Erogatore di vapore in acciaio inox, con aromaterapia
Generatore di vapore (da posizionare sopra il tetto) con cover di copertura
Bagno turco multiclimate
Tastiera touch
Sensore di temperatura
Cromoterapia (solo per tetto con soffione in acciaio con cromoterapia 30x30 cm)

Shower column with steam generator clour therapy

MEASUREMENT
24x3,8x190 H cm
4 kW - 4,5 m³
3 kW - 3,5 m³
2,5 kW - 3 m³

Polished stainless steel construction materia

SPECIFICATIONS
3-way thermostatic mixer (of which 1 for the shower head positioned on the roof)
Handheld shower head
3 vertical jets
Stainless steel steam dispenser, with aromatherapy
Steam generator (to be positioned over the roof) with coverage
Multiclimate Turkish bath
Touch keypad
Temperature sensor
Colour therapy (only for roofs with steel shower head with colour therapy 30x30 cm)

Generatore di vapore Steam generator



33x22x20 H cm

G-Steam è la nuova colonna doccia con generatore di vapore ideata dal reparto Ricerca e Sviluppo di Hafro.

G-Steam is a new shower column with steam generator designed by the Hafro Research and Development department.

GEMINI

collection

Gemini è la risposta più efficace al desiderio di un bagno turco che si inserisce perfettamente nel bagno di casa, da installare direttamente senza bisogno di opere particolari. Ma non solo, Gemini è anche una chiusura per semplici ambienti doccia, da personalizzare con piatti e colonne che soddisfano il proprio gusto estetico e le personali esigenze di relax quotidiano.

Gemini is the most effective answer to the desire for a Turkish bath that fits perfectly in the bathroom of the house, to be installed directly without the need for special works. But not only, Gemini is also a closure for simple shower rooms, to be customized with shower tray and columns that satisfy their aesthetic taste and personal needs for daily relaxation.

**Box doccia con tetto per
hammam o ambienti doccia.**

*The roof for hammams or
shower rooms.*



Gemini scorrevole

collection

Box doccia con tetto per hammam
o ambienti doccia.

*Shower cubicles with roof for hammam
or shower rooms.*



L'anta scorrevole con sgancio rapido permette
una pulizia accurata del piatto e dell'interno doccia.

*Sliding door with fast releasable system for a perfect
cleaning of shower tray and inside glass.*

CARATTERISTICHE

Gemini 5 scorrevole SX 150x100x214 H
piatto Flat in Tecnotek H 2,5 - 150x100 cm

SPECIFICATIONS

*Gemini 5 sliding doors left 150x100x214 H
Flat in Tecnotek tray H 2,5 - 150x100 cm White*





Gemini battente

collection

Box doccia con tetto per hammam
o ambienti doccia.
*Shower cubicles with roof for hammam
or shower rooms.*

CARATTERISTICHE
Gemini 4 battente DX 150x100x214 H cm
con soffione integrato 26x26 cm
piatto Flat in Tecnotek H 2,5 - 150x100 cm Bianco

SPECIFICATIONS
Gemini 4 hinged doors right 150x100x214 H cm
with integrated shower head 26x26 cm
Flat in Tecnotek tray H 2,5 - 150x100 cm White

Gemini battente

collection



I profili sottili incorniciano i cristalli e valorizzano il design minimal della chiusura. L'essenzialità estetica è il punto in comune di tutte le versioni.

The thin frame of the glasses enhance the minimal design of the shower cabins. The aesthetic essentiality is the common point of all the versions.



Maniglia e cerniera condividono le stesse linee squadrate e permettono di aprire e chiudere l'anta battente agevolmente.

Handle and hinge share the same squared lines and allow the hinged door to be opened and closed easily.

Gemini battente

collection

+ Rigenera 200

CARATTERISTICHE

Rigenera 200
Gemini battente 180x100x214 H

SPECIFICATIONS

Rigenera 200
Gemini hinged doors 180x100x214 H



Gemini pivottante

collection

+ G-Steam BASE

Box doccia con tetto per hammam
o ambienti doccia.

Shower cubicles with roof for hammam
or shower rooms.



Pivottante Gemini 5
Gemini 5 pivoting



CARATTERISTICHE

Gemini 5 pivottante DX 150x90x214 H
con soffione integrato 26x26 cm
Colonna G-Steam Base
piatto Flat in Tecnotek H 2,5 - 150x100 cm

SPECIFICATIONS

Gemini 5 pivoting right 150x90x214 H
with integrated shower head 26x26 cm
G-Steam Base cloumn
Flat in Tecnotek tray H 2,5 - 150x100 cm White

Tetto Gemini

Gemini roof

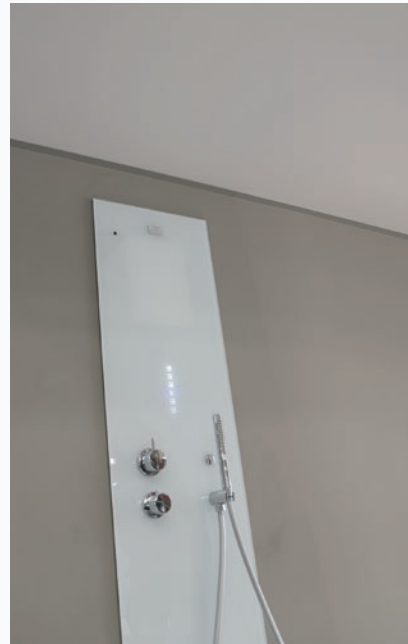

Tetto semplice.
Simple roof.

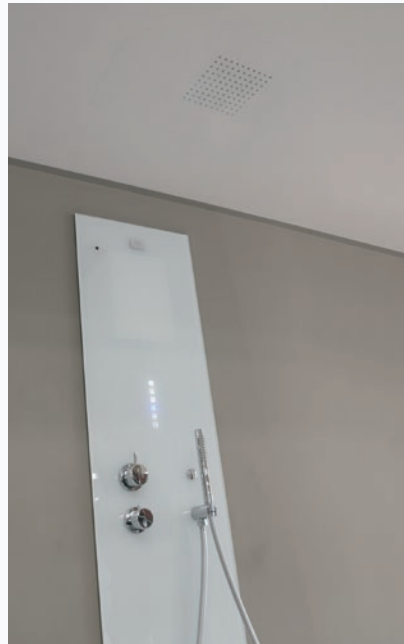

Tetto con soffione.
Built-in roof headshower.



Tetto con soffione e cromoterapia.
Built-in roof headshower and colour therapy.

Si può scegliere il tetto in versione semplice, oppure con accessorio:
- soffione 26 x 26 cm;
- soffione con cromoterapia 30 x 30 per programma Rigenera o G-Steam.

*You can choose the roof in simple version, or with accessory:
- 26 x 26 cm shower head;
- 30 x 30 chromotherapy shower head for the Rigenera or G-Steam program.*

Accessori

Accessories

PANCHE E ACCESSORI

1. Seduta a muro ribaltabile 36x30x8 H.
2. Sgabello in acrilico 40x24,5x44 H.
3. Sgabello in acciaio e Corian® 38x27,8x44 H.
4. Sgabelli in Solid Surface bianco 42x25x44 H e 37,5x25x41,5 H.

BENCHES AND ACCESSORIES

1. Wall-mount folding seat 36x30x8 H.
2. Acrylic stool 40x24.5x44 H.
3. Steel and Corian® stool 38x27.8x44 H.
4. Solid surface stool 42x25x44 H and 37.5x25x41.5 H.

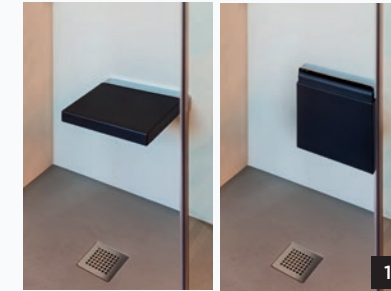

Installazione Gemini Gemini installation

Angolo Corner

Gemini 4 _ Porta laterale Side door



Scorrevole
Sliding doors

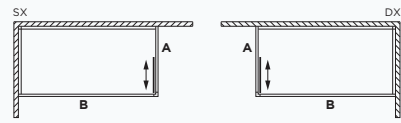

Battente senza profilo inferiore
Hinged doors without lower profile

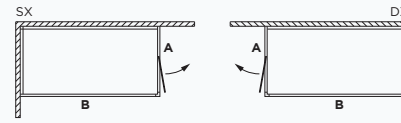

Pivottante con profilo inferiore
Pivoting with lower profile

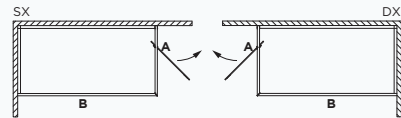

Gemini 5 _ Porta frontale Front door



Scorrevole
Sliding doors

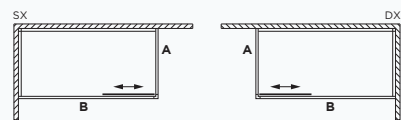

Battente senza profilo inferiore
Hinged doors without lower profile

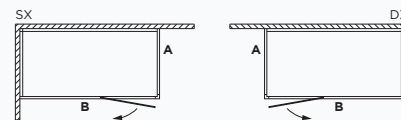

Pivottante con profilo inferiore
Pivoting with lower profile

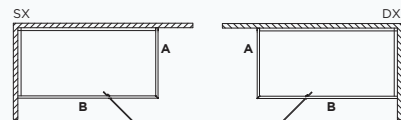

Parete Wall

Gemini 6 _ Porta laterale Side door



Scorrevole
Sliding doors

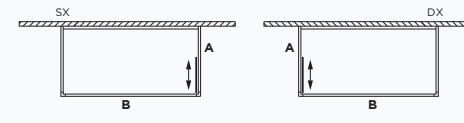

Battente senza profilo inferiore
Hinged doors without lower profile

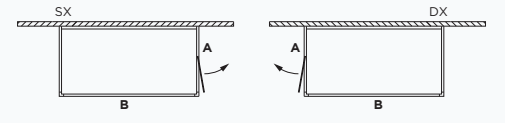

Pivottante con profilo inferiore
Pivoting with lower profile

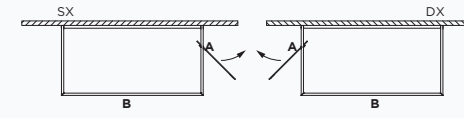

Gemini 7 _ Porta frontale Front door



Scorrevole
Sliding doors

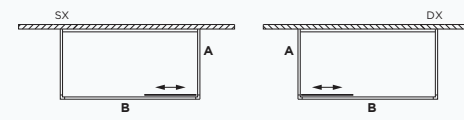

Battente senza profilo inferiore
Hinged doors without lower profile

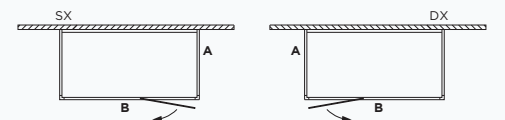

Pivottante con profilo inferiore
Pivoting with lower profile

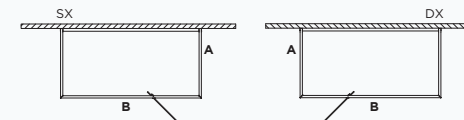

Nicchia Niche

Gemini 8 _



Scorrevole
Sliding doors

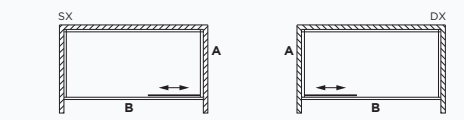

Battente senza profilo inferiore
Hinged doors without lower profile

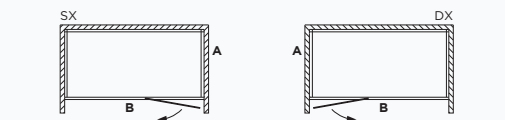

Pivottante con profilo inferiore
Pivoting with lower profile

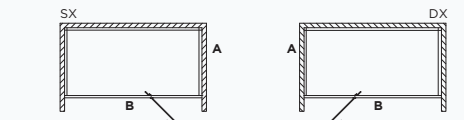



BOX DOCCIA MULTIFUNZIONE

MULTIFUNCTION
SHOWER CUBICLES

Tempo ²⁴⁸

Soul ²⁵⁶

Sound ²⁶²

New Bi-size ²⁷²

BOX DOCCIA CON HAMMAM E IDROMASSAGGIO

*SHOWER CUBICLES WITH
TURKISH BATH AND HYDROMASSAGE*

Le cabine doccia con bagno turco e idromassaggio Hafro sono un angolo attrezzato per un benessere "prêt-à-porter", da vivere quando si vuole nella comodità della propria casa. Oltre al soffione centrale integrato al tetto dei box doccia, da cui scende un vigoroso getto d'acqua, le pareti delle cabine doccia multifunzione sono dotate di getti per l'idromassaggio verticale: l'acqua esce nebulizzata, pulsata e a pioggia. In più, nella doccia multifunzione ci si può godere l'effetto della cromoterapia.

Hafro shower cubicles with Turkish bath and whirlpool are a fully equipped, ready-to-use wellness area that you can make use of whenever you want from the comfort of your own home. In addition to a central shower head built into the cubicle roof, from which a strong jet of water comes down, the walls of the multifunction shower cubicle are equipped with vertical whirlpool jets: water comes out in spray, pulsed, and rain. Users can also enjoy the effects of colour therapy in the multifunction cubicle.

BOX DOCCIA CON IDROMASSAGGIO E HAMMAM

*SHOWER CUBICLES WITH
HYDROMASSAGE AND TURKISH BATH*

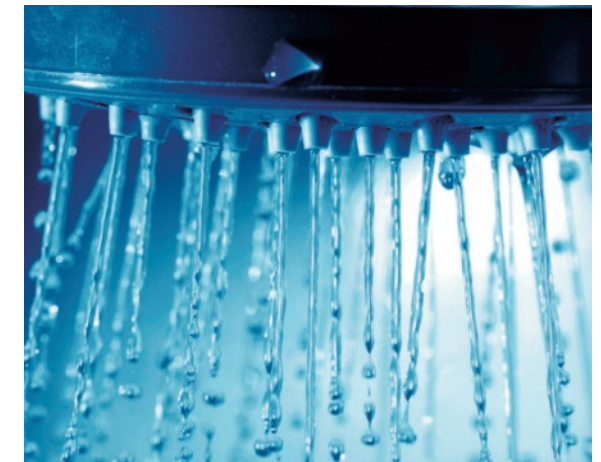

Una doccia di vapore.

A steam shower.

All'interno della doccia, il vapore sprigiona tutto il suo potere rilassante. Il bagno turco stimola tutto l'organismo agendo sulla circolazione del sangue e sulle tensioni muscolari, in modo da ridurre lo stress. La combinazione tra vapore, doccia e l'idromassaggio permette di godere pienamente dei benefici dell'acqua in un unico ambiente.

Steam releases all its relaxing power inside the shower. A Turkish bath stimulates the entire body and reduces stress with positive effects on blood circulation and muscle tension. The combination of steam, shower, and whirlpool allows you to enjoy all the benefits of water in one place.

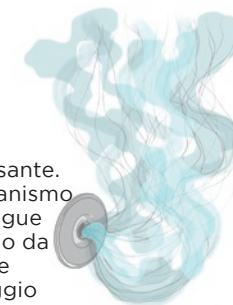

L'idromassaggio nella doccia.

The whirlpool shower bath.

Nell'ambiente doccia multifunzione, i jet idromassaggio completano il percorso benessere sfruttando la pressione e la temperatura dell'acqua. La posizione delle bocchette e le differenti modalità di getto sono studiate per agire su tutte le parti del corpo: i benefici si sentiranno su collo, braccia, schiena e gambe, ma anche sulla mente.

In the multifunction shower cubicle, the whirlpool jets complete the wellness path exploiting the water pressure and temperature. The position of the nozzles and the different water jet modes are designed to act on the whole body. You can feel all the benefits on your neck, arms, back, legs, but also on your mind.

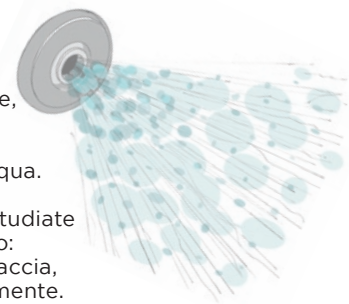

TEMPO

collection

Cabina multifunzione con allestimento wellness completo, per un ambiente di comfort e bellezza. L'illuminazione è realizzata in modo scenografico: una serie di led distribuiti sul tetto crea questa spettacolare opzione per la cromoterapia disponibile nei modelli junior.

È uno dei tanti particolari di pregio, come il display digitale, la mensola porta oggetti a due livelli e la seduta in acrilico trasparente. Il comfort raggiunge livelli di eccellenza, unendo tecnica e design.

Multifunction wellness shower cubicle for your comfort and beauty.

The illumination is realized as a set design: a series of leds distributed on the roof creates this spectacular option for the chrome therapy available in junior models.

It is just one of the details of merit as the digital display, the two levels object holder shelf and the transparent acrylic seat. The comfort reaches levels of excellence matching technique and design.



Tempo

collection



DIMENSIONI
120x80 cm

CARATTERISTICHE
angolo sx nero

DIMENSIONS
120x80 cm

SPECIFICATIONS
corner left black

Tempo

collection

DIMENSIONI
90x90 cm

CARATTERISTICHE
a parete grigio

DIMENSIONS
90x90 cm

SPECIFICATIONS
wall grey



Tempo

Caratteristiche tecniche Technical details

SISTEMI

Tempo Integra
Tempo Junior
Tempo curvo Integra
Tempo curvo Junior

INSTALLAZIONE

Angolo - Parete
Nicchia

Apertura laterale Open side

SX LH DX RH

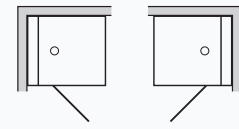

80x90 90x90 100x80
100x90 120x80 100x100

Apertura frontale Open front

SX LH DX RH

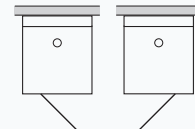

90x80 90x90

Apertura laterale Open side

SX LH DX RH

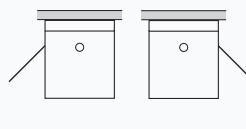

90x80 90x90

SYSTEMS

Tempo Integra
Tempo Junior
Tempo curved Integra
Tempo curved Junior

INSTALLATION

Corner - Wall
Niche

Apertura laterale Open side

SX LH DX RH

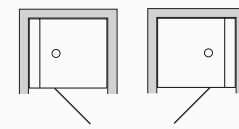

90x80 90x90 100x80
100x90 120x80 100x100

Apertura laterale Open side

SX LH DX RH

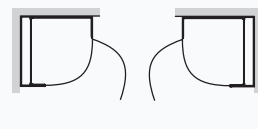

90x80 100x90 100x100
120x80

CARATTERISTICHE

Maniglia La maniglia metallica è un brillante esempio di equilibrio tra forma e funzione. In linea con l'estetica dal gusto tecnico, crea con l'essenzialità del rigore geometrico una facile apertura.

Rubinetteria termostatica La forma dei rubinetti termostatici è una vera stilizzazione geometrica. In due semplici cilindri cromati è racchiusa la capacità di regolare l'acqua. Il design si esprime in ogni dettaglio.

Appendiabiti e connessione in doccia con il tuo iPod Anche sotto l'acqua puoi rimanere in compagnia delle tue canzoni preferite grazie alla presa jack integrata, posta sotto l'appendiabiti cromato.

SPECIFICATIONS

Handle Metallic handle it is a smart example of equilibrium between shape and usability. Besides the technical shape creates an easy opening together with the geometric exactness.

Thermostatic tap The particular shape of thermostatic faucets is a true geometric stylization. In two simple chromed cylinders is contained the ability to regulate the water. Design is expressed in every single details.

Towel hook with iPod plug A shower with your iPod. Even under the water it's possible remain together with your favourite songs thanks to the built-in jack, under the chromed towel hanger.

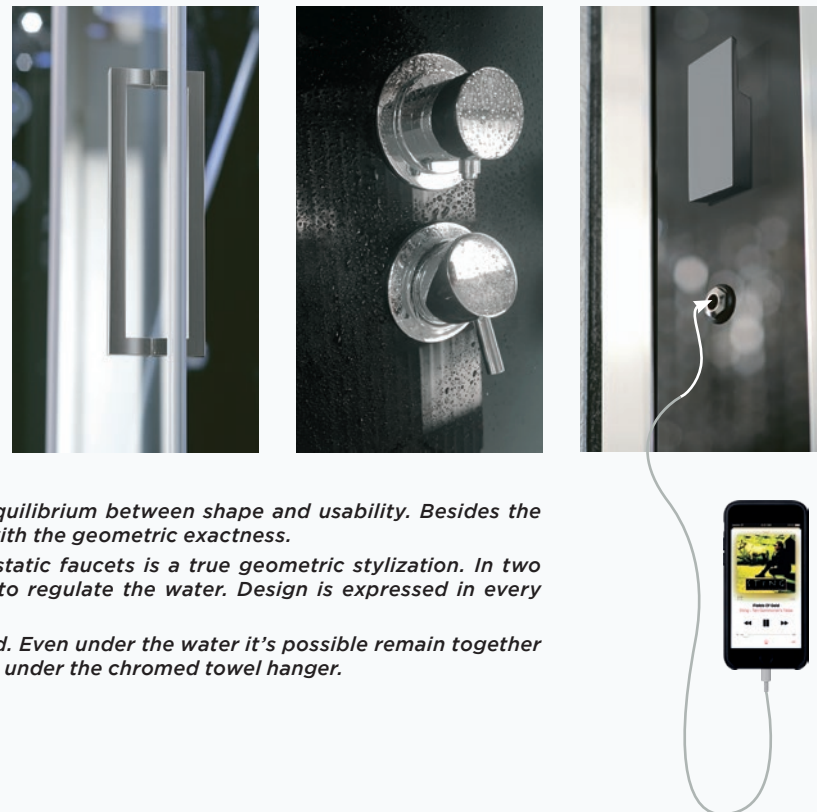

CROMOTERAPIA

La luce colorata ha una diretta influenza sullo stato d'animo. La sua lunghezza d'onda, opportunamente veicolata, penetra nella pelle favorendo le funzioni biologiche e il riequilibrio psico-fisico. L'associazione alle altre tecniche come l'idromassaggio o il bagno turco completa l'approccio di Hafro al benessere.

CROMOTHERAPY

Coloured light has a direct influence on state of mind. Its wavelength, it penetrates in the skin favouring the biological functions and the psycho-physical equilibrium. The association to the other techniques as the hydromassage or the turkish bath completes Hafro approach to comfort.



SGABELLO

Che abbia la trasparenza del plexiglas, la lucentezza del metallo o la delicatezza del Corian®, lo sgabello è un elemento fondamentale per il comfort del box doccia con idromassaggio o bagno turco. La posizione seduta consente di apprezzare al meglio le straordinarie virtù di questo box.

SEATS

Whatever the transparency of the plexiglas or the brightness of the metal, the seat is a fundamental element for the comfort of the shower cabin with hydromassage or steam bath. The sitting position allows to appreciate to the best the extraordinary virtues of this cabin.



FINITURE FINISHES



Rosso Granato
Red



Moka

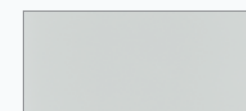

Bianco
White



Grigio
Grey



Ruggine
Orange Rust



Blu Oltremare
Oversea Blue



Nero
Black

SOUL

collection

Cristalli temperati con profili cromati.
L'effetto del soffione centrale potenziato da soffioni verticali.
In 120 per 80 cm ci sono il piacere e l'eleganza.

*Crystal glass with chromed profile.
central head shower is powered by vertical jets.
Comfort and elegance in a beautiful shower cabin.*



Soul

collection



DIMENSIONI
100x90 cm

CARATTERISTICHE
sx junior bianco

DIMENSIONS
100x90 cm

SPECIFICATIONS
left junior white

Soul

Caratteristiche tecniche Technical details

SISTEMI

Soul Integra
tetto + soffione

Soul Junior
tetto + soffione
+ display

INSTALLAZIONE

Angolo - Nicchia

ALTEZZA PIATTO

H 8 cm - H 14 cm

SYSTEMS

Soul Integra
roof + headshower

Soul Junior
roof + headshower
+ display

INSTALLATION

Corner - Niche

SHOWER TRAY HEIGHT

8 cm H - 14 cm H

Angolo

Corner

SX LH

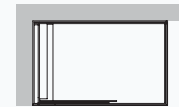

100x70

120x70

140x70

DX RH



100x80

120x80

140x80

100x90

120x90

140x90

Nicchia

Niche

SX LH



100x70

120x70

140x70

DX RH



100x80

120x80

140x80

100x90

120x90

140x90

DISPOSITIVI E DOTAZIONI

Il telecomando nella versione Junior controlla tutte le funzioni, la frequenza, il volume della radio, la temperatura e la durata del bagno turco. Luce di serie o accessorio cromoterapia. L'ambiente si colora di luce per potenziare l'effetto rigenerante della doccia.

DEVICES AND EQUIPMENT

The remote control in the Junior version manage all the functions, the frequency, the volume of the radio, the temperature and duration of the Turkish bath. Standard light or chromotherapy accessory. The space get colored by light to enhance the effect of rejuvenating shower.



Piatto doccia H 8 cm con profilo e copripiletta in Acciaio Inox.
Shower tray 8 cm H with Stainless steel profile and waste cover.



Piatto doccia H 14 cm con profilo e copripiletta in Acciaio Inox.
Shower tray 14 cm H with Stainless steel profile and waste cover.

ACCESSORI ACCESSORIES



Soffione 20x20 con luce di serie o accessorio cromoterapia per versione Junior.

20x20 shower head with standard light or chromotherapy as option for the Junior version.



Display per la visualizzazione dei parametri per versione Junior. Telecomando con calamita.

Display for the parameters for the Junior version. Remote control with magnet to be placed in the shower panel.



Vano tecnico ispezionabile facilmente removibile con mensola integrata.

Easily inspectable technical compartment with integrated shelf.

FINITURE

Le pareti e il tetto del box sono realizzati con un pannello composito formato da: alluminio, materiale poliuretano ad alta densità e, nella parte esterna, alluminio rivestito con una speciale finitura acrilica Bianco Lucido. Anche il piatto doccia del box è realizzato con un pannello composito formato da: alluminio, PVC e alluminio rivestito con una speciale finitura acrilica Bianco Lucido.

FINISHES

The walls and the roof of the cubicle are made of a composite panel consisting of: aluminum, high-density polyurethane material and, on the outside, aluminum coated with a special Glossy White acrylic finish. The shower tray is also made of a composite panel made of aluminum, PVC and aluminum, coated with a special Glossy White acrylic finish.



Acrilico Bianco Lucido. Copripiletta in acciaio. Profilo in acciaio inox.

Gloss White Acrylic. Steel waste cover. Stainless steel profile.

SOUND

collection

Cabina doccia multifunzione in cristallo e alluminio.
Cristalli temperati e profilo cromato.
L'innovazione della colonna con installazione ad angolo.
La comodità della seduta apri e chiudi.

*Multifunction shower cabin in crystal glass and aluminum.
Crystal glass walls with chromed profiles.
Corner installation shower column is the focus point
of this shower cabin.
Open/ close seat means comfort and relax.*



Sound

collection

**CARATTERISTICHE**

Sound Integra
pannelli finitura Nero
piatto doccia 90x90x8 H cm

SPECIFICATIONS

Sound Integra
black panels finishes
shower tray 90x90x8 H cm

Sound

collection



CARATTERISTICHE

Sound Junior
pannelli finitura Bianco
piatto doccia tondo 90x90x8 H cm

SPECIFICATIONS

Sound Junior
white panels finishes
round shower tray 90x90x8 H cm

Dispositivi e dotazioni Sound

Sound devices and equipment



Sedile reclinabile
Open/close seat



Doccetta con asta doccia
Handshower on slide bar



Piatto doccia H 8 cm
Shower tray 8 cm H



Piatto doccia H 14 cm
Shower tray 14 cm H

Sound

Caratteristiche tecniche Technical details

VERSIONE STEP

Cabina doccia multifunzione - colonna ad angolo - pareti laterali in cristallo 6 mm - doccetta con supporto magnetico - 3 jets idromassaggio - piatto doccia in acrilico - chiusura scorrevole finitura brillantata e in cristallo di sicurezza 6 mm - pannello piatto H 8 (prevedere incasso per piletta) /14 cm

VERSIONE INTEGRA

Cabina doccia multifunzione - colonna ad angolo - pareti laterali in cristallo 6 mm - doccetta con supporto magnetico - 3 jets idromassaggio - piatto doccia in acrilico - chiusura scorrevole finitura brillantata e in cristallo di sicurezza 6 mm - pannello piatto H 8 (prevedere incasso per piletta) /14 cm - tetto con soffione

VERSIONE COMFORT

Cabina doccia multifunzione - colonna ad angolo - pareti laterali in cristallo 6 mm - doccetta con supporto magnetico - 3 jets idromassaggio - piatto doccia in acrilico - chiusura scorrevole finitura brillantata e in cristallo di sicurezza 6 mm - pannello piatto H 8 (prevedere incasso per piletta) /14 cm - tetto con soffione - sedile reclinabile - erogatore di vapore per bagno turco con comando meccanico (on-off)

VERSIONE JUNIOR

Cabina doccia multifunzione - colonna ad angolo - pareti laterali in cristallo 6 mm - doccetta con supporto magnetico - 3 jets idromassaggio - piatto doccia in acrilico - chiusura scorrevole finitura brillantata e in cristallo di sicurezza 6 mm - pannello piatto H 8 (prevedere incasso per piletta) /14 cm - tetto con soffione - sedile reclinabile - radio - erogatore di vapore per bagno turco con display e comandi digitali

STEP VERSION

Multifunction shower cabin - corner installation shower column - magnetic hand shower - acrylic shower tray 8 cm H (enclosed drain required) / 14 cm - crystal glass sliding door enclosure 6 mm thick - n. 3 hydromassage jets

INTEGRA VERSION

Multifunction shower cabin - corner installation shower column - magnetic hand shower - acrylic shower tray 8 cm H (enclosed drain required) / 14 cm - crystal glass sliding door enclosure 6 mm thick - built-in roof head shower - n. 3 hydromassage jets

COMFORT VERSION

Multifunction shower cabin - corner installation shower column - magnetic hand shower - acrylic shower tray 8 cm H (enclosed drain required) / 14 cm - crystal glass sliding door enclosure 6 mm thick - built-in roof head shower - open close seat - steam generator - mechanic control - n. 3 hydromassage jets

JUNIOR VERSION

Multifunction shower cabin - corner installation shower column - magnetic hand shower - acrylic shower tray 8 cm H (enclosed drain required) / 14 cm - crystal glass sliding door enclosure 6 mm thick - built-in roof head shower - open close seat - steam generator - mechanic control - n. 3 hydromassage jets - radio - steam generator with digital control

INSTALLAZIONE INSTALLATION

Dimensioni angolo Corner measurement

90x70	100x80
100x70	120x80

SX LH

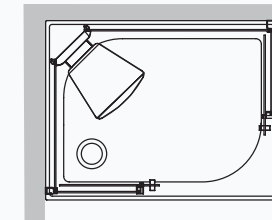

DX RH

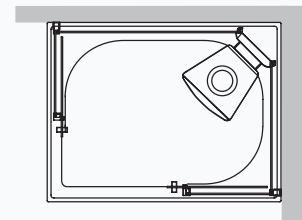

Dimensioni angolo Corner measurement

80x80	90x90
-------	-------

SX LH

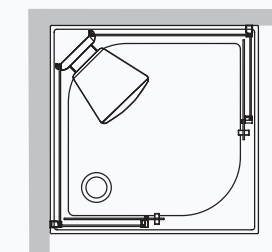

DX RH

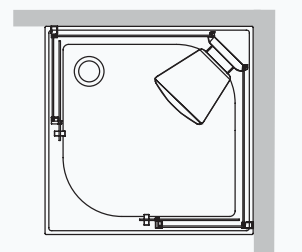

Dimensioni angolo tondo Round corner measurement

90x90

SX LH

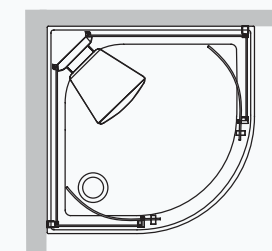

DX RH

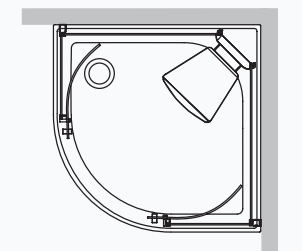

COLORI PARETI BOX BOX PANELS COLORS



Bianco
White

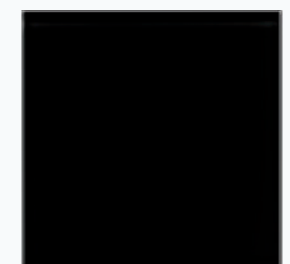

Nero
Black

NEW BI-SIZE

collection

DIMENSIONI

80x80
90x90
Reversibile 70x90

INSTALLAZIONE

Angolo

MEASUREMENT

80x80
90x90
Reversible 70x90

Installation

Corner

VERSIONE INTEGRA

Cabina doccia multifunzione
Completa di parete attrezzata
Miscelatore
Asta doccia con doccetta
Soffione
Nr. 12 jets idromassaggio
Piatto doccia con pannello estraibile
Piletta con sifone ispezionabile
Chiusura in cristallo di sicurezza 6 mm
con sgancio anta agevolato
Tetto
Specchio

INTEGRA VERSION

*Multifunctions shower cabin
With equipped panel
Mixer
Handshower on slide bar
Handshower
Nr. 12 hydromassage jets
Shower tray with removable panel
Waste with inspectionable siphon
Safety 6 mm crystal enclosure
with easy hanging system
Roof
Mirror*

VERSIONE JUNIOR

Cabina doccia multifunzione con bagno
turco kW 2,2 con sistema multiclimate
Elettronica con diagnostica
Visualizzazione temperatura
Visualizzazione timer
Sistema di decalcificazione caldaia
Completa di parete attrezzata
Miscelatore - Asta doccia con doccetta
Soffione - Luce alogena
Nr. 12 jets idromassaggio effetto pulsato
Piatto doccia con pannello estraibile
Piletta con sifone ispezionabile
Chiusura in cristallo di sicurezza 6 mm
con sgancio anta agevolato
Tetto - Specchio - Allarme
Erogatore vapore con aromaterapia
e fitoterapia

JUNIOR VERSION

*Multifunctions shower cabin with steambath
kW 2.2 with multi-climate system
Electronics with diagnostic
Temperature display
Timer display
Anti-limestone system for boiler
Equipped panel
Mixer - Handshower on slide bar
Handshower - Light
Nr. 12 pulsed hydromassage jets
Shower tray with removable panel
Drain
Safety 6 mm crystal enclosure
with easy hanging system
Roof - Mirror - Alarm
Steam dispenser with aromatherapy
and phytotherapy diffuser*





VASCHE IDROMASSAGGIO

HYDROMASSAGE TUBS

Rio ²⁸⁶

Calle | Move ²⁹²

Sensual ³⁰⁶

Minerva ³¹²

Bolla ³²⁸

For All ³⁵²

Mode ³⁵⁶

Era Plus | Era ³⁶²

Eva ³⁷⁰

Zaphiro ³⁷⁶

Oasy ³⁷⁷

Duo ³⁷⁸

Ondaria ³⁷⁹

Gamma ³⁸⁰

Igloo ³⁸¹

Ego ³⁸²

Diva ³⁸³

Nova ³⁸⁴

Nova Plus ³⁸⁷

Old Tme ³⁸⁸

I BENEFICI DELL'IDROMASSAGGIO

The benefits of whirlpools



Nella vasca idromassaggio, la forza e il calore dell'acqua, insieme alla pressione dell'aria, sono gli elementi chiave per un trattamento benefico che, in base alle esigenze, può essere rilassante o rivitalizzante. Dopo una giornata stressante o dopo un'attività sportiva faticosa, immergersi nella vasca idromassaggio è l'ideale sia per riacquistare energia sia per prepararsi a un sonno ristoratore:

- Bagno rivitalizzante: 20-25 minuti in acqua quasi fredda (17-27°C).
- Bagno rilassante: 15-20 minuti in acqua calda (34-38°C).

In the bathtub, the strength and the warmth of the water, together with the air pressure, are the key elements for a beneficial treatment that, depending on the needs, can be relaxing or revitalizing. After a stressful day or after a strenuous sporting activity, relaxing in the bathtub is ideal both for regaining energy and for preparing to a restful sleep:

- *Revitalizing bath: 20-25 minutes in almost cold water (17-27 ° C).*
- *Relaxing bath: 15-20 minutes in hot water (34-38 ° C).*



UNA VASCA IDROMASSAGGIO PER OGNI AMBIENTE.

A whirlpool tub for every environment.

Il calore dell'acqua attenua i dolori articolari e muscolari, mentre l'idromassaggio favorisce la circolazione sanguigna e linfatica, specie nelle gambe, aiutando a risolvere i problemi di cattiva circolazione, ritenzione idrica e cellulite. Nelle vasche idromassaggio Hafro, si può anche ascoltare la propria musica preferita e godere l'effetto della cromoterapia e delle fragranze per l'aromaterapia.

The warmth of the water attenuates the joint and muscular pains, while the hydromassage promotes blood and lymphatic circulation, especially in the legs, helping to solve the problems of poor circulation, water retention and cellulitis. In the Hafro whirlpools you can also listen to your favorite music and enjoy the effect of color therapy and aromatherapy fragrances.

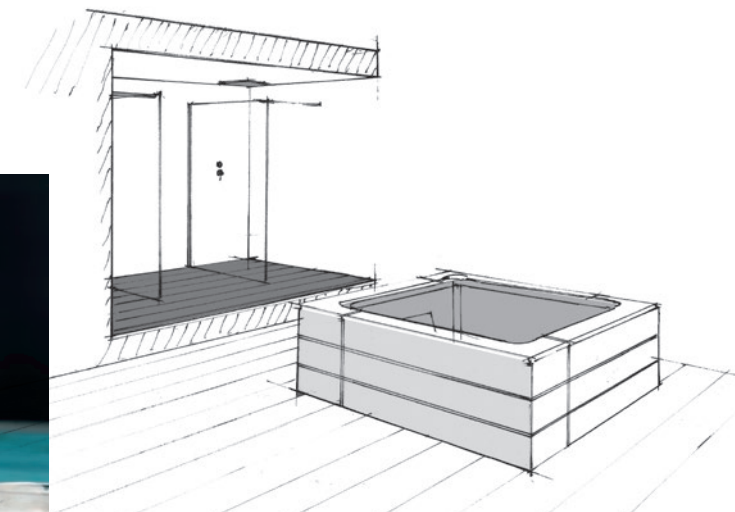
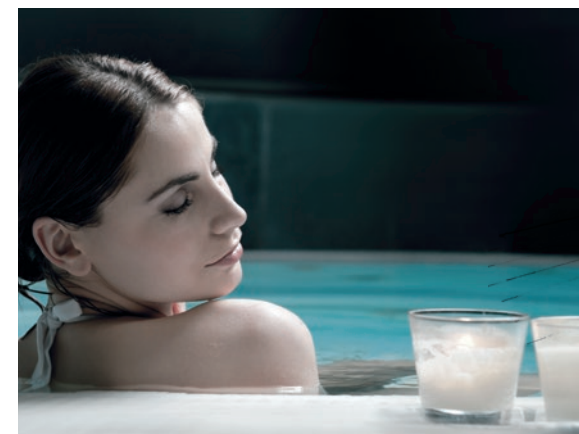

SISTEMI IDROMASSAGGIO

Whirlpool systems

Nelle vasche idromassaggio Hafro, l'effetto benefico è dato dall'azione di diversi sistemi idromassaggio, ad aria e ad acqua, organizzati in molteplici configurazioni.

The beneficial effect of Hafro whirlpool baths is due to the action of different air and water whirlpool systems arranged in multiple configurations.



AIRPOOL (optional ozonoterapia)

Dalle bocchette escono infinite micro bollicine d'aria che rilassano in profondità anche chi ha pelle e capillari delicati. Il sistema Airpool è disponibile anche con ozonoterapia, che permette un effetto stimolante della circolazione periferica e una pulizia a fondo della cute, grazie al potere disinfettante naturale dell'ozono.

Numerous jets produce endless micro air bubbles which deeply relax even sensitive skin and capillaries. Airpool system is also available with ozone therapy. Thanks to the natural disinfectant power of the ozone it allows a stimulating effect of the peripheral circulation and a deep cleansing of the skin.



WHIRLPOOL

Acqua e aria si riuniscono in un getto ideale per il trattamento vascolare, per riequilibrare il metabolismo dei tessuti e rassodare il corpo.

Water and air gather in an ideal throw for the vascular treatment, to balance the metabolism of tissues and to harden the body.

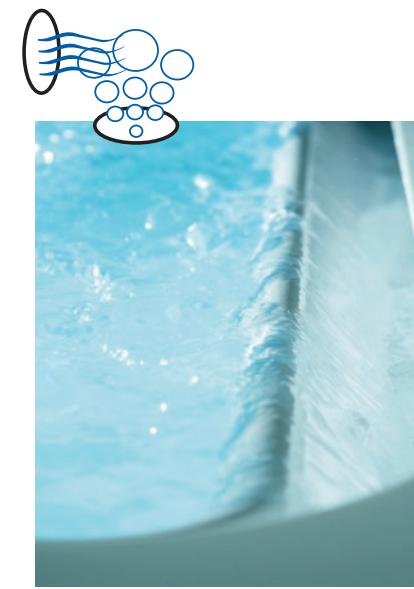

WHIRLPOOL AIRPOOL

Le due dimensioni dell'idromassaggio insieme per sciogliere le tensioni, tonificare i tessuti e stimolare la circolazione in un abbraccio globale e completo.

Two different hydromassage system are combined together to dissolve the tensions, to invigorate the tissues and to stimulate the blood circulation in a global and complete approach.



PROFESSIONAL WHIRLPOOL AIRPOOL

Tutte le funzioni Whirlpool Airpool per un idromassaggio completo e rigenerante.

All the Whirlpool Airpool functions for a complete and regenerating water massage.

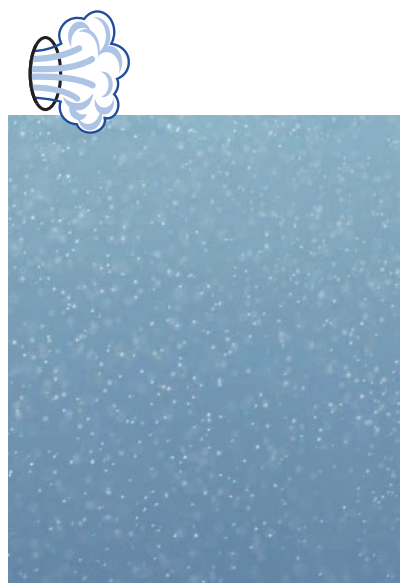

MICROSILK®

È un sistema di idromassaggio che sfrutta un getto speciale per produrre una nuvola di micro-bolle contenenti un miscuglio di ossigeno, nitrogeno ed altri gas.

It is a whirlpool system which uses a special jet to produce a cloud of micro-bubbles containing a mixture of oxygen, nitrogen and other gases.

Microsilik®

L'innovativo sistema di idromassaggio The innovative whirlpool system



Microsilik® è la nuova frontiera dell'idroterapia, un'autentica fonte di benessere e giovinezza. Un getto speciale produce una nuvola di microbolle di ossigeno, che idrata la pelle e ha effetti benefici sulla respirazione. Grazie alle loro piccole dimensioni, le bolle entrano nei pori della pelle, eliminando le impurità e portando ossigeno ai tessuti. Con un elevato effetto detox, idratante e anti-invecchiamento, il sistema Microsilik® è ideale anche per chi soffre di psoriasi. Inoltre, le microbolle rilasciano alti livelli di anioni (particelle con carica elettrica negativa) che infondono una sensazione di relax e migliorano il sonno.

The innovative whirlpool system Microsilik® is the new frontier of hydrotherapy, a true source of wellness and youth. A special jet produces a cloud of microbubbles of oxygen, which moisturizes the skin and has beneficial effects on breathing. Thanks to their small size, the bubbles enter the pores of the skin, eliminating impurities and bringing oxygen to the tissues. With a high detox, moisturizing and anti-aging effect, the Microsilik® system is also ideal for those suffering from psoriasis. In addition, microbubbles release high levels of anions (particles with a negative electrical charge) that infuse a feeling of relaxation and improve sleep.

NATURALE PULIZIA E IDRATAZIONE DELLA PELLE

Microsilik® ossigena l'acqua fino al 70% in più rispetto ai sistemi utilizzati nelle normali SPA. Le microbolle hanno un diametro di 50 micron e sono in grado di idratare ed esfoliare la pelle, rimuovendo le impurità.

EFFETTO SAUNA

Rompendosi, le microbolle rilasciano energia termica nell'atmosfera e mantengono il calore nella vasca e intorno al corpo. Questo crea un effetto sauna che migliora la circolazione, aumenta l'attività cardiovascolare e apre i pori della pelle favorendo il rilascio delle tossine.

MASSIMO RELAX CON GLI IONI A CARICA NEGATIVA

Tramite un getto speciale, il sistema di idromassaggio Microsilik® produce una nuvola che avvolge il corpo con ioni negativi, utili per combattere i radicali liberi e migliorare i livelli di serotonina, con un immediato effetto positivo sulla pelle e sull'umore.

NATURAL CLEANING AND HYDRATION OF THE SKIN

Microsilik® oxygenates water up to 70% more than the systems used in normal SPAs. The micro-bubbles have a diameter of 50 microns and are able to hydrate and exfoliate the skin, removing impurities.

SAUNA EFFECT

By breaking, the microbubbles release thermal energy into the atmosphere and keep the heat in the bathtub and around the body. This creates a sauna effect that improves circulation, increases cardiovascular activity and opens the pores of the skin, promoting the release of toxins.

MAXIMUM RELAXATION THROUGH IONS WITH NEGATIVE CHARGE

Using a special jet, the Microsilik® whirlpool system produces a cloud that envelops the body with negative ions, useful to fight free radicals and improve serotonin levels, with an immediate positive effect on the skin and mood.

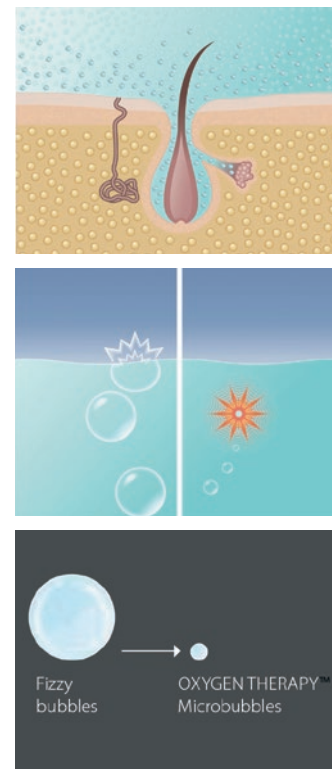

CROMOTERAPIA Colour therapy

La luce regola l'organismo sia dal punto di vista psicologico sia da quello fisiologico. Infatti influisce sull'umore, sulla memoria, sull'attenzione, ma anche sulla temperatura corporea e sul battito cardiaco. L'influenza sullo stato d'animo dipende anche dall'effetto che il colore della luce ha sul sistema percettivo e sulla psiche. Ad esempio, il rosso aumenta i livelli di reattività, mentre il blu predispone alla calma e all'introspezione.

Light regulates the body, psychologically and physiologically. In fact it affects mood, memory, attention, but also on body temperature and heart rate. Its influence on mood also depends on the effect that the colour of the light has on the perceptual system and on the psyche. For example, red increases levels of reactivity, while blue induces calm and introspection.

AROMATERAPIA E FITOTERAPIA Aromatherapy and phytotherapy

La fitoterapia, cioè l'uso a scopo terapeutico delle piante, è una pratica molto antica. Da foglie, fiori, frutti, semi, corteccia, legno, radici etc. di varie piante si ricavano gli oli essenziali, che sono degli estratti aromatici. Liberando le essenze profumate nell'acqua o nell'ambiente, un trattamento sfrutta i benefici dell'aromaterapia e le molteplici proprietà degli oli essenziali: antispasmodica, mucolitica, ansiolitica, analgesica etc. Inoltre, i profumi influiscono sullo stato d'animo, anche in base memoria olfattiva che si associa alla loro fragranza.

Phytotherapy, or rather the use of plants for medicinal purposes, is a very ancient practice. Essential oils, which are aromatic extracts, are derived from leaves, flowers, fruits, seeds, bark, wood, roots etc. Releasing these perfume essences in water or in the environment for treatments that exploits the benefits of aromatherapy and the multiple properties of essential oils: antispasmodic, mucolytic, anxiolytic, analgesic, etc. In addition, aromas affect state of mind, including in the olfactory memory base that is associated with their fragrance.

BOCCHETTE

Diversi stili e tipologie di jet idromassaggio
Different styles and types of whirlpool jets



Due versioni, Cromo o Bianco, per le bocchette idromassaggio orientabili che rilasciano un getto diretto ed energetico per rendere completo e intenso il benessere.

Two versions, Chrome or White, for adjustable whirlpool jets that release a direct and energetic jet to make wellness complete and intense.

Modelli: **BOLLA - FOR ALL**

Le bocchette orientabili, disponibili in versione Cromo o Bianco, permettono di direzionare il getto a seconda delle esigenze. L'intensità si può regolare chiudendo parzialmente le bocchette.

The adjustable jets, available in Chrome or White versions, allow the jet to be directed according to requirements. The intensity can be adjusted by partially closing the jets.

Modelli: **DUO - ONDARIA - GAMMA - IGLOO - EGO - DIVA - NOVA - NOVA PLUS**



Disponibili nella versione Bianco, le bocchette a filo sono orientabili e lasciano la superficie della vasca esteticamente pulita integrandosi nella superficie.

Available in the White version, the flush to bathtub side jets are adjustable and leave the surface of the bathtub aesthetically clean and integrated into the surface.

Modelli: **MINERVA - MODE - ERA - ERA PLUS - EVA - ZAPHIRO - OASY**

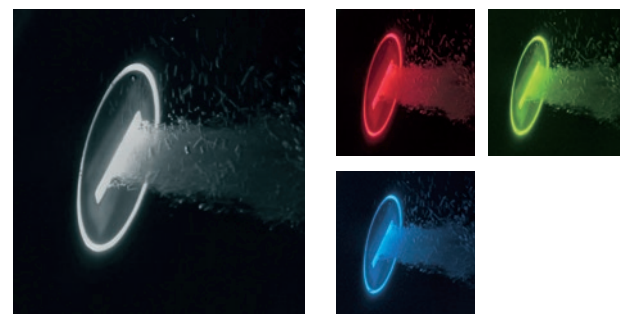

Le bocchette idromassaggio a filo vasca sono invisibili, direzionabili e retroilluminate dalla cromoterapia. Il design piatto e minimal dà continuità alla superficie e garantisce una funzionalità completa.

The flush to bathtub side hydromassage jets are invisible, directional and backlit for chromotherapy. The flat and minimal design gives continuity to the surface and guarantees complete functionality.

Modello: **RIO**

DISINFEZIONI

Più sistemi per pulire la vasca idromassaggio
More systems to clean the bathtub



Sistema liquido

La disinfezione dell'impianto idromassaggio è di serie nei sistemi digitali. Il processo avviene a vasca piena grazie all'uso di liquido disinfettante che agisce in tutte le parti dell'impianto premendo l'apposito tasto che raffigura il simbolo disinfezione.

Sistema a diffusione Biosan

Negli impianti idromassaggio manuali la disinfezione (optional) si attiva con il sistema BIOSAN. Il processo avviene mentre si fa l'idromassaggio grazie al passaggio dell'acqua, attraverso un contenitore, di pastiglie di Bromo che mantengono inalterato il pH dell'acqua. Queste pastiglie vanno sostituite ogni 200 cicli di idromassaggio.

Sistema a raggi UV

I raggi ultravioletti (UV) di una certa lunghezza d'onda hanno azione germicida. Questo sistema è usato nelle vasche idromassaggio per purificare con una lampada a raggi UV l'acqua, che attraversa l'impianto di ricircolo, da batteri, virus, muffe e altri microrganismi.

Liquid system

The disinfection of the hydromassage system is standard in digital systems. The process has to be started with full filled tub thanks to a disinfection liquid which will in this way be distributed in the complete system, this process will start pressing the disinfection button.

Biosan diffusion system

The disinfection of the manual hydromassage system (optional) can be done with the system BIOSAN. The process starts during the hydromassage thanks to water going through a plastic tank with Bromo tablets, maintaining the pH of the water unaltered. The tablets have to be reinserted in the plastic tank after 200 hydromassages.

UV ray system

Ultraviolet rays (UV) of a certain wavelength have germicidal action. This whirlpool bath system uses a UV ray lamp to purify water that passes through the recirculation system of bacteria, viruses, mould, and other micro-organisms.

MATERIALI

Wellness collection
MATERIALS



TECNOTEK

Materiale nobile grazie alla sua composizione con resine acriliche al 100% dà la possibilità di realizzare una gamma di vasche da bagno dalla forma ovale e rettangolare.

Tecnotek is a noble material thanks to its composition with 100% acrylic resins. It gives the possibility of creating a range of oval and rectangular bathtubs.



CORIAN®

Il Corian® è un materiale tecnologico evoluto che rende la tua vasca protagonista. Composto da minerali naturali e polimeri acrilici di elevata purezza.

Corian® is the cutting-edge technological material that will shine a spotlight on your bathtub. Composed of natural minerals and high purity acrylics polymers.



ACRILICO

Un materiale termico, piacevole al contatto con il corpo e brillante alla vista. Le superfici in acrilico sono lisce e non porose, antiscivolo, resistenti a graffi e urti e di facile manutenzione.

A thermal material, pleasant in contact with the body and bright to the eye. Acrylic surfaces are smooth and non-porous, non-slip, resistant to scratches and bumps and easy to maintain.



ACRILICO OPACO

L'acrilico è disponibile anche in versione opaca: le superfici mantengono inalterata tutte le caratteristiche di resistenza, ma esteticamente si contraddistinguono per una finitura moderna.

The acrylic is also available in a matt version: the surfaces retain all the characteristics of resistance, but aesthetically distinguish themselves for a modern finish.

Modelli: RIO - CALLE - MOVE



Facile pulizia
Easy to clean

Antibatterico
Antibacterial

Alta resistenza
High resistance

Atossico
Non-toxic

Modello: SENSUAL



Facile pulizia
Easy to clean

Antibatterico
Antibacterial

Alta resistenza
High resistance

Atossico
Non-toxic

Modelli: MODE - NOVA - ERA - EVA
DUO ONDARIA GAMMA - IGLOO
EGO - DIVA - ZAPHIRO



Facile pulizia
Easy to clean

Antibatterico
Antibacterial

Modelli: LINEA ERA
(esclusa vasca Era 14x140)
(excluding Era tub 140x140)



Facile pulizia
Easy to clean

Antibatterico
Antibacterial

RIO

collection

Hafro presenta la nuova frontiera dell'idromassaggio: Rio, la vasca idromassaggio che rilassa corpo e mente attraverso i benefici dell'acqua, della cromoterapia... e del silenzio.

8 jet idromassaggio a filo vasca e dal design minimal non interrompono la continuità della superficie in Tecnotek e allo stesso tempo garantiscono un piacevole trattamento rilassante.

Hafro presents the new hydromassage innovation: Ryo, the whirlpool bath that relaxes body and mind through the benefits of water, chromotherapy and silence.

8 whirlpool water jets flush with the tub and with a minimal design do not interrupt the continuity of the Tecnotek surface and at the same time guarantee a pleasant relaxing treatment.

Una vasca perfetta per chi cerca di coniugare estetica e funzionalità.

A perfect tub for those seeking to combine aesthetics and functionality.



Rio

collection



DIMENSIONI
190x90 cm ultrawhirpool

DIMENSIONS
190x90 cm ultrawhirpool

L'idromassaggio silenzioso Ultrawhirlpool

Silent Ultrawhirlpool

Le bocchette idromassaggio sono integrate nella superficie e retroilluminate dalla cromoterapia.

The whirlpool water jets are integrated into the surface and provided with backlit chromotherapy.

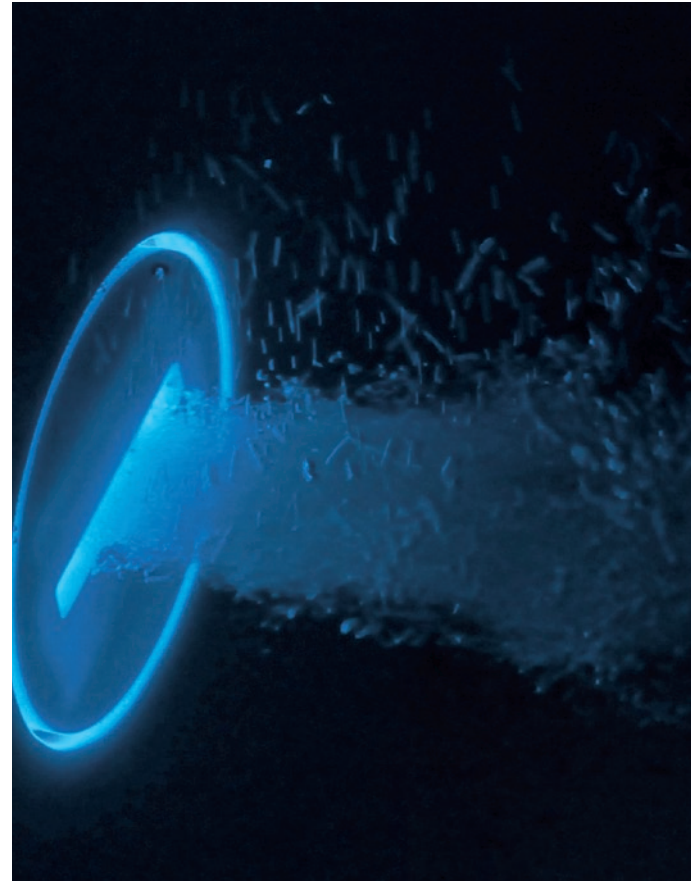

Rubinetteria PRESTIGE B2
Mix quattro fori con bocca di erogazione

PRESTIGE B2 Taps
Mix four holes with water spout



La tastiera permette di regolare con stile l'intensità dell'idromassaggio e le funzioni della vasca.

The digital touch control allows you to adjust with style the intensity of the whirlpool and the functions of the bath.

Per creare un'armonia cromatica all'interno dell'ambiente bagno, lo stile della vasca può essere abbinato all'arredo bagno Geromin scegliendo finiture coordinate tra loro.

To create a chromatic harmony inside the bathroom, the style of the bathtub can be combined with the Geromin bathroom furniture by choosing coordinated finishes.

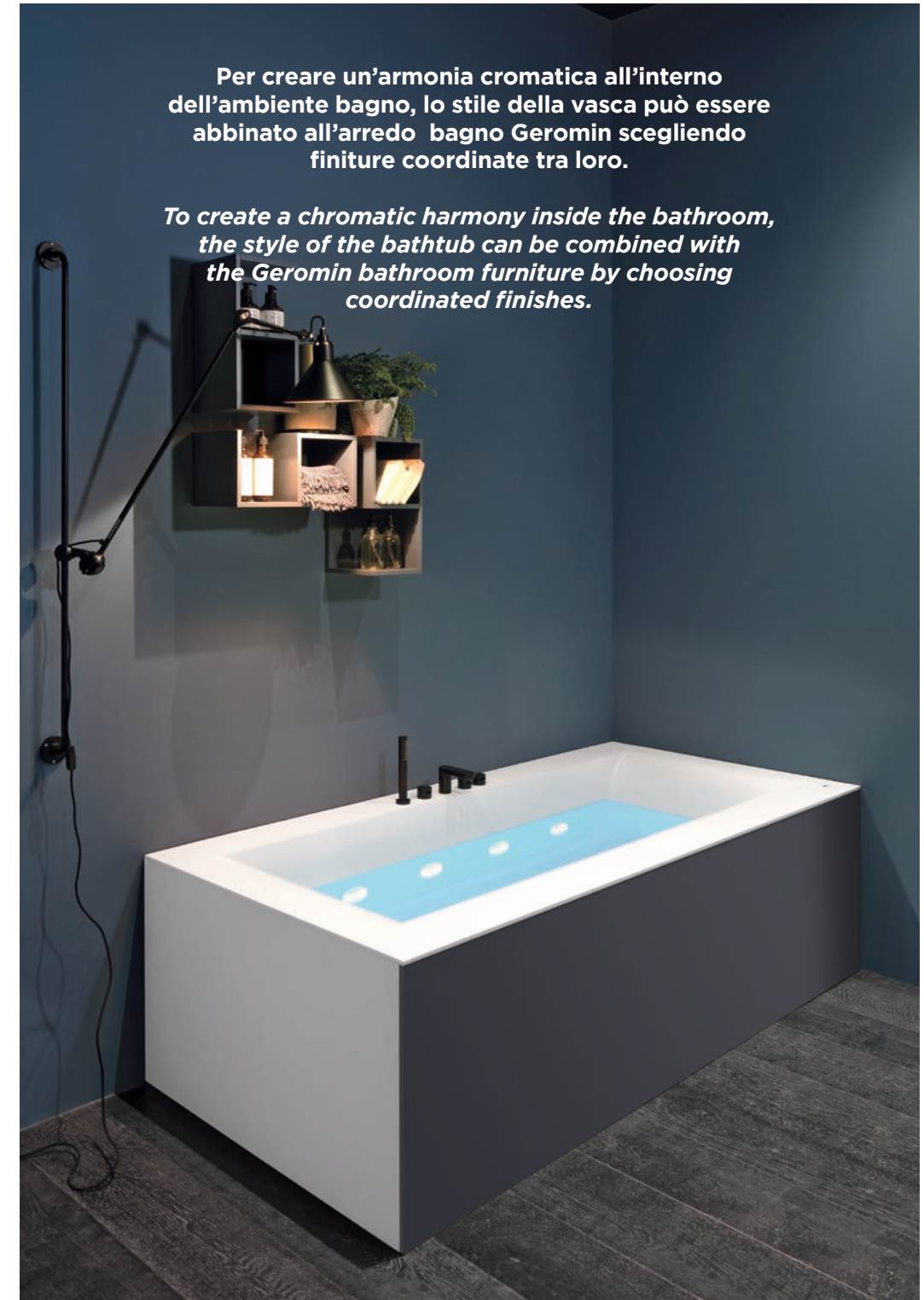

CALLE MOVE

collection

Calle e Move sono realizzate in Tecnotek, materiale innovativo dalle caratteristiche uniche. Sorprendente al tatto, offre una sensazione calda e piacevole. Le sue forme fluide e l'assenza di giunzioni regalano benessere alla mente. Materiale versatile compatto, ripristinabile, omogeneo, in tutto il suo spessore e di facile pulizia, grazie ad uno approfondito studio di ricerca chimica la sua brillantezza e colorazione rimangono inalterate nel tempo.

Calle and Move are made of Tecnotek, an innovative material with unique characteristics. Surprising to the touch, it offers a warm and pleasant feeling. Its fluid forms and the absence of joints give wellbeing to our mind. Tecnotek is a compact, restorable and homogeneous material, in all its thickness and it is easy to clean, thanks to a deep study of chemical research its brilliance and coloration remain unaltered over time.



Calle ovale
collection

Calle rettangolare

collection



DIMENSIONI
180x80 cm

CARATTERISTICHE
rettangolare ad angolo sx
con rubinetteria Prestige B2

DIMENSIONS
180x80 cm

SPECIFICATIONS
rectangular corner left position
with Prestige B2 tap



Move ovale

collection



DIMENSIONI
170x70 cm

CARATTERISTICHE
ovale freestanding con
rubinetteria e piantana tonda
con bocca di erogazione

DIMENSIONS
170x70 cm

SPECIFICATIONS
oval freestanding position
with floor standing tap - rounded
shape with water filling spout

Move rettangolare

collection



DIMENSIONI
170x70 cm

CARATTERISTICHE
rettangolare freestanding
con rubinetteria quadra con
bocca di erogazione

DIMENSIONS
170x70 cm

SPECIFICATIONS
rectangular freestanding
position with squarer shape
tap with filling spout

Calle ovale

Caratteristiche tecniche
Technical details

SISTEMI

Vasca con telaio

Colonna di scarico integrata nella vasca c/troppo pieno
Piletta pop-up, con tappo in finitura
Sifone scarico in plastica

Vasca Airpool

Colonna di scarico integrata nella vasca c/troppo pieno
Piletta pop-up con tappo in finitura
Sifone scarico in plastica
Vasca digitale airpool
12 iniettori airpool
Programma pulsato
Massaggio microdiffuso con elettrosoffiante a velocità regolabile

Sensore di livello

Air clean system
Cromoterapia

INSTALLAZIONE

Freestanding - Parete
Angolo - Nicchia

SYSTEMS

Bathtub with supporting frame

In bathtub integrated drain column with overflow
Pop-up drain, with plug in same finishing
Plastic siphon

Bathtub with airpool system

In bathtub integrated drain column with overflow
Pop-up drain, with plug in same finishing
Plastic siphon
Bathtub with airpool digital system
12 airjets

Pulsed program

Micro-diffused massage with adjustable speed air blower
Water level sensor
Air clean system
Chromotherapy

INSTALLATION

Freestanding - Wall
Corner - Niche

RUBINETTERIA PRESTIGE

Rubinetteria Prestige B1 Mix tre fori + bocca erogazione a cascata.
Rubinetteria Prestige B2 quattro fori + bocca erogazione a cascata.

PRESTIGE TAPS

Prestige B1 - 3 holes tap + water cascade.

Prestige B2 - 4 holes tap + water cascade.



Prestige B1

Prestige B2

TASTIERA DIGITALE

Comandi accensione e di regolazione dell'idromassaggio airpool con più o meno intensità sono incassati nella struttura e si attivano con una semplice e lieve pressione.

DIGITAL KEYPAD

The commands to turn on and regulate the airpool hydromassage to different levels of intensity are built into the structure and turned on simply with light pressure.

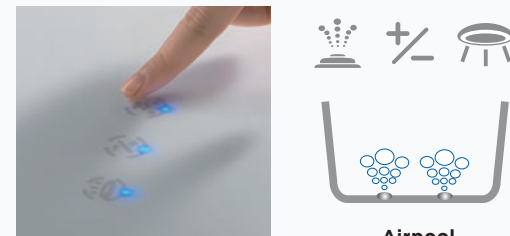

Airpool

FINITURA TECNOTEK TECNOTEK FINISH

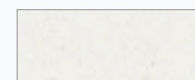

Bianco
White

FREESTANDING

155x73
170x80



PARETE WALL

155x73
170x80



ANGOLO CORNER

165x73
180x80



SX LH

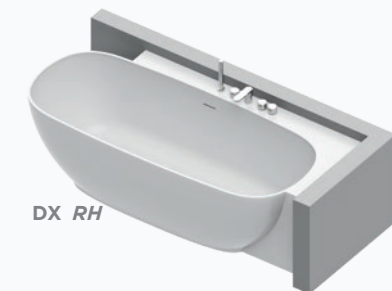

DX RH

NICCHIA NICHE

175x73
190x80

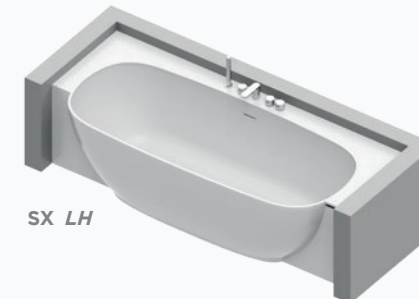

SX LH

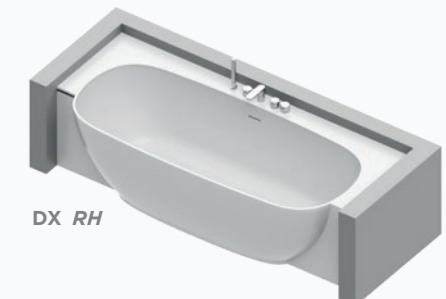

DX RH

Calle rettangolare

Caratteristiche tecniche
Technical details

SISTEMI

Vasca con telaio

Colonna di scarico integrata nella vasca c/troppo pieno
Piletta pop-up, con tappo in finitura
Sifone scarico in plastica

Vasca Airpool

Colonna di scarico integrata nella vasca c/troppo pieno
Piletta pop-up con tappo in finitura
Sifone scarico in plastica
Vasca digitale airpool
12 iniettori airpool
Programma pulsato
Massaggio microdiffuso con elettrosoffiante a velocità regolabile

Sensore di livello
Air clean system
Cromoterapia

INSTALLAZIONE

Freestanding - Parete
Angolo - Nicchia

SYSTEMS

Bathtub with supporting frame

In bathtub integrated drain column with overflow
Pop-up drain, with plug in same finishing
Plastic siphon

Bathtub with airpool system

In bathtub integrated drain column with overflow
Pop-up drain, with plug in same finishing
Plastic siphon
Bathtub with airpool digital system
12 airjets

Pulsed program
Micro-diffused massage with adjustable speed air blower
Water level sensor
Air clean system
Chromotherapy

INSTALLATION

Freestanding - Wall
Corner - Niche

RUBINETTERIA PRESTIGE

Rubinetteria Prestige B1 Mix tre fori + bocca erogazione a cascata.
Rubinetteria Prestige B2 quattro fori + bocca erogazione a cascata.

PRESTIGE TAPS

Prestige B1 - 3 holes tap + water cascade.

Prestige B2 - 4 holes tap + water cascade.



Prestige B1

Prestige B2

TASTIERA DIGITALE

Comandi accensione e di regolazione dell'idromassaggio airpool con più o meno intensità sono incassati nella struttura e si attivano con una semplice e lieve pressione.

DIGITAL KEYPAD

The commands to turn on and regulate the airpool hydromassage to different levels of intensity are built into the structure and turned on simply with light pressure.

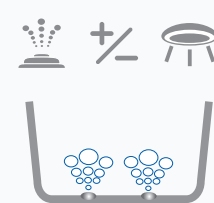
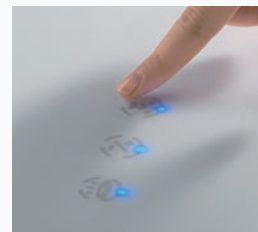

Airpool

FINITURA TECNOTEK TECNOTEK FINISH

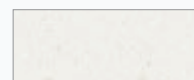

Bianco
White

FREESTANDING

170x80

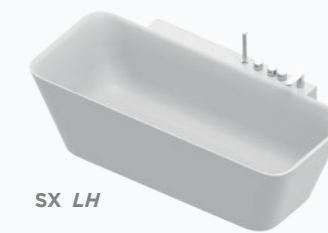

SX LH



DX RH

PARETE WALL

170x80

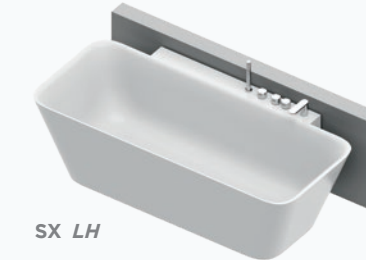

SX LH



DX RH

ANGOLO CORNER

180x80



SX LH



DX RH

NICCHIA NICHE

190x80

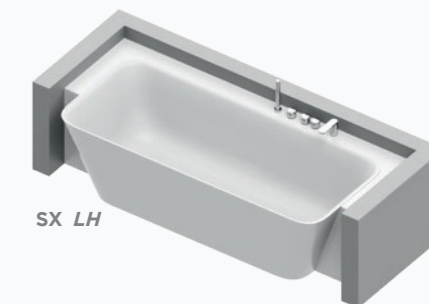

SX LH

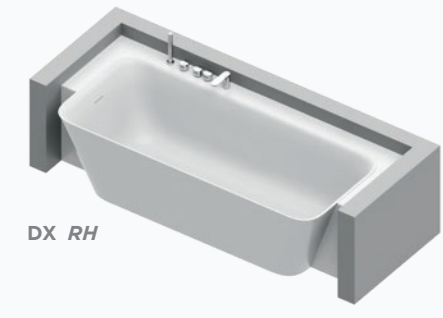

DX RH

Move ovale

Caratteristiche tecniche
Technical details

SISTEMI

Colonna di scarico
integrata nella vasca
Troppopieno
Piletta pop-up con
tappo in finitura
Sifone scarico in
plastica

INSTALLAZIONE

Freestanding

SYSTEMS

*In bathtub
integrated drain
column
Overflow
Pop-up drain,
with plug in same
finishing
Plastic siphon*

INSTALLATION

Freestanding

RUBINETTERIA PIANTANA

Rubinetteria a piantana quadra
e tonda con bocca erogazione
e mix finitura cromo.

PEDESTAL TAPS

*Floor standing tap - square
and rounded shape with water
filling spout, chrome finish.*



Quadra



Tonda

INSTALLAZIONI

INSTALLATION

Freestanding
155x63



170x70



FINITURE FINISHES

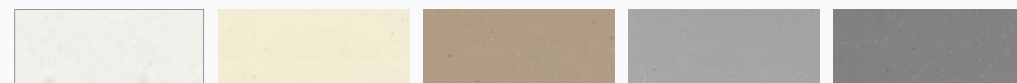

Bianco
White

Crema
Cream

Terra
Land

Grigio Chiaro
Light Grey

Grigio Scuro
Dark Grey

Move rettangolare

Caratteristiche tecniche
Technical details

SISTEMI

Colonna di scarico
integrata nella vasca
Troppopieno
Piletta pop-up con
tappo in finitura
Sifone scarico in
plastica

INSTALLAZIONE

Freestanding

SYSTEMS

*In bathtub
integrated drain
column
Overflow
Pop-up drain,
with plug in same
finishing
Plastic siphon*

INSTALLATION

Freestanding

RUBINETTERIA PIANTANA

Rubinetteria a piantana quadra
e tonda con bocca erogazione
e mix finitura cromo.

PEDESTAL TAPS

*Floor standing tap - square
and rounded shape with water
filling spout, chrome finish.*



Quadra



Tonda

INSTALLAZIONI

INSTALLATION

Freestanding
170x70



FINITURE FINISHES

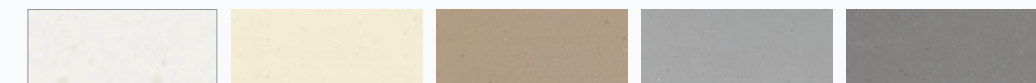

Bianco
White

Crema
Cream

Terra
Land

Grigio Chiaro
Light Grey

Grigio Scuro
Dark Grey

SENSUAL

collection

Realizzata in Corian® e dotata di sistema idromassaggio airpool, diventa il centro di una sala da bagno dove l'estetica contemporanea dà un nuovo significato alle funzioni, aprendo orizzonti di stile, comfort e progettualità. Sensual arricchisce l'acqua di nuove sensazioni e l'arredo di nuove potenzialità.

Corian® made and supplied with airpool hydro-massage system, becomes the heart of bathroom where beauty gives a new meaning to the functions, and open new horizons of style, comfort and project. Sensual enriches the water of new feelings and furnishing of new potentialities.

Vasca idromassaggio dal design fluido e funzionale, grazie anche alla seduta ergonomica, permette una posizione di assoluto relax.

The whirlpool bathtub with a fluid and functional design. Its ergonomic seat allows for a position of absolute relaxation.



Sensual

collection



DIMENSIONI
190x100 cm

CARATTERISTICHE
vasca airpool

DIMENSIONS
190x100 cm

SPECIFICATIONS
airpool bathtub

Sensual

Caratteristiche tecniche
Technical details

Parete Wall

Angolo Corner

Freestanding

250x120



220x120



190x120



190x100
190x90
190x80



180x100
180x90
180x80



RUBINETTERIA "LOFT"

Un design geometrico per la rubinetteria da bordo vasca con tre o quattro fori, doccetta e bocca di erogazione oppure in versione piantana con bocca di erogazione e doccetta.

"LOFT" FAUCETS

A geometric design for bath taps with three or four holes, shower head and spout or in the upright version with spout and shower head.



Loft B1

Loft B2

FINITURE

Le finiture della linea Sensual prevedono il rivestimento in MDF laccato nelle finiture dei colori Geromin (o nelle personalizzazioni RAL), con i ripiani nei modelli più grandi e con pannello liscio negli altri.

FINISHES

Sensual finishes are in lacquered MDF (Geromin colours or customized RAL selection). The bigger version are provided with holding shelves, the smallest with smooth panels.



Pannelli e cassettiere in MDF laccato
I laccati sono disponibili in tutti i colori della mazzetta.
MDF painted panels
Lacquers are available in all colours of the selection swatch.

TASTIERA DIGITALE

Comandi accensione e di regolazione dell'idromassaggio airpool con più o meno intensità sono incassati nella struttura e si attivano con una semplice e lieve pressione.

DIGITAL KEYPAD

The commands to turn on and regulate the airpool hydromassage to different levels of intensity are built into the structure and turned on simply with light pressure.

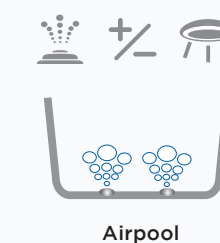

MINERVA

collection

La vasca Minerva è una vera e propria rivoluzione, ha la forma e le dimensioni di una vasca normale, con le caratteristiche della minipiscina e con il vantaggio di non essere svuotata dopo l'uso. Vasca per uso interno ed esterno con sistema automatico di ricircolo che mantiene l'acqua alla temperatura impostata e sempre pulita, grazie ad una disinfezione UV che elimina i batteri e un filtro che trattiene le impurità.

Inoltre, tra le dotazioni è compresa di cromoterapia e accessorio audio Bluetooth.

Minerva è una vasca intelligente per tanti aspetti: per i consumi, perchè assicura un risparmio di energia; per il tempo, perchè è sempre pronta; per l'utilizzo più continuo e facilitato, perchè non deve essere riempita ogni volta.

The minerva bathtub is a real revolution, has the form and dimensions of a normal bathtub, with the features of the hot tub and with the advantage of not to be drained after use. Bath for indoor and outdoor use with automatic recirculation system that keeps the water at the settled temperature and always clean, thanks to a uv disinfection system that eliminates bacteria and a filter that treats the impurities. Also, available chromotherapy equipment and the bluetooth audio accessory. Minerva is an intelligent bathtub for many aspects: for consumption, because it provides an energy saving; for the time, because it is always ready; for the most continuous and easy use, because it should not be filled every time.



Indoor

Nella versione da interno, la vasca Minerva è disponibile con diversi sistemi idromassaggio: Airpool (micro-bolle d'aria dalle bocchette a fondo vasca), Whirlpool (getti di acqua e aria dalle bocchette laterali) o combinazione Whirlpool Airpool. Minerva Indoor con sistema Whirlpool Airpool è disponibile anche con ricircolo automatico ed è dotata di tastiera touch screen in cristallo, filtraggio a cartuccia, disinfezione dell'acqua a UV e riscaldatore.

The Minerva indoor whirlpool tubs are available with different whirlpool systems: Airpool (air microbubbles at the bottom of the tub), Whirlpool (water and air jets from the side nozzles) or Whirlpool Airpool combination. Minerva Indoor with Whirlpool Airpool System is also available with automatic recirculation. It comes with a crystal touchscreen keypad, cartridge filtration, UV water disinfection, and a heater.

Outdoor

Nella versione da esterno, la vasca Minerva con impianto idromassaggio combinato Whirlpool Airpool è dotata di sistema automatico di ricircolo dell'acqua, filtraggio a cartuccia e disinfezione UV dell'acqua. La testiera touch in cristallo e il riscaldatore per il mantenimento della temperatura completano la funzionalità. Sono disponibili come optional l'impianto audio bluetooth e i pannelli di rivestimento in ecomalta, mentre la copertura termica è un accessorio.

In the outdoor version, the Minerva Whirlpool Airpool tub comes with an automatic recirculation system, cartridge filtration, UV water disinfection, a crystal touchscreen keypad, and a heater to maintain the temperature. The Bluetooth audio system and ecomalta panels are available as options, while the thermo cover is available as an accessory.

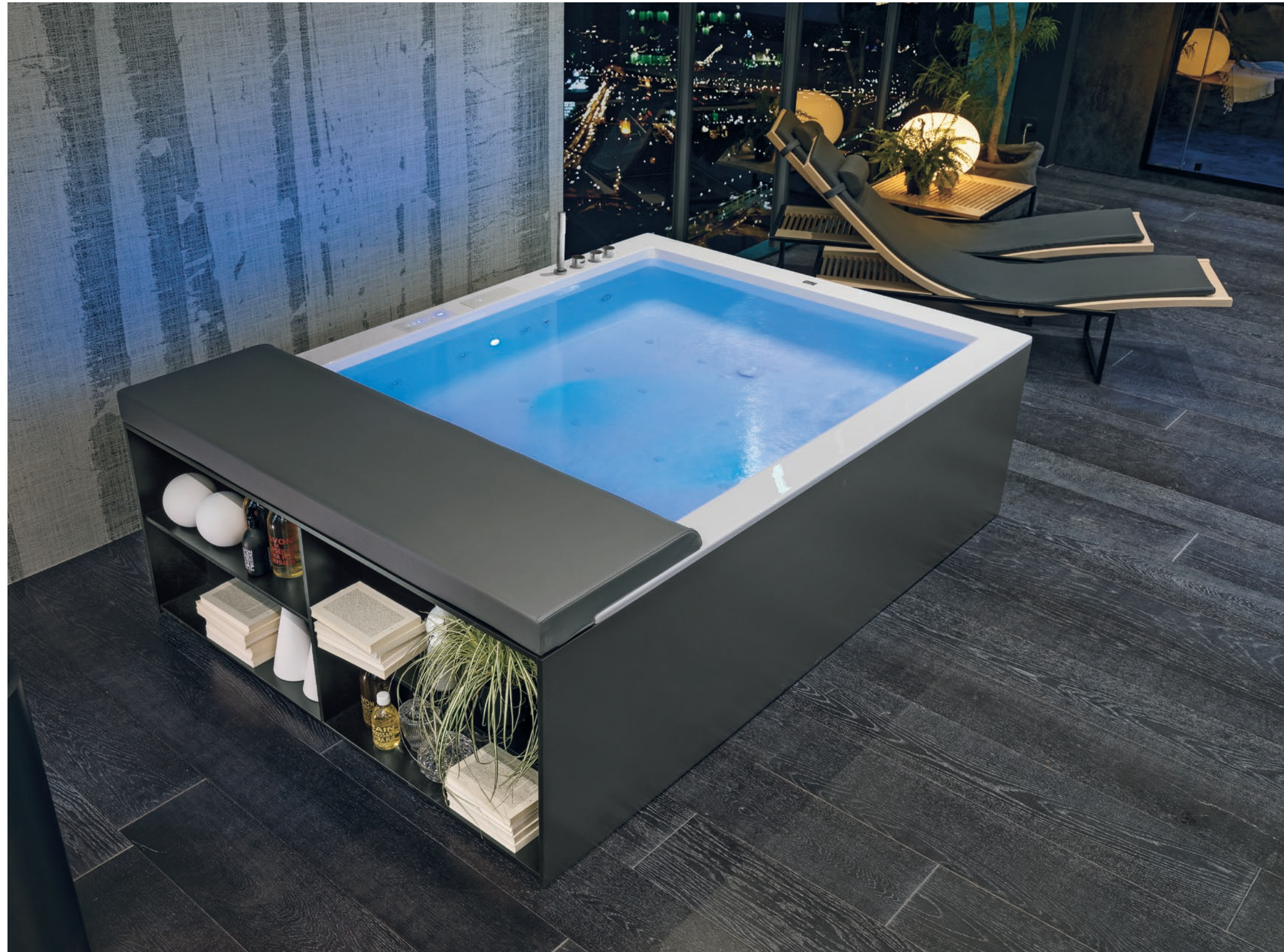

Minerva indoor

collection

DIMENSIONI
215x150 cm

CARATTERISTICHE
vasca con cuscino
e troppo pieno a sfioro

DIMENSIONS
215x150 cm

SPECIFICATIONS
tub with cushion
and 'infinity' overflow

Minerva indoor

collection



DIMENSIONI
200x150 cm

CARATTERISTICHE
vasca con troppo
pieno a sfioro

DIMENSIONS
200x150 cm

SPECIFICATIONS
tub with 'infinity'
overflow

Minerva indoor

collection



DIMENSIONI
215x150 cm

CARATTERISTICHE
vasca con cuscino
e troppo pieno a sfioro

DIMENSIONS
215x150 cm

SPECIFICATIONS
tub with cushion
and 'infinity' overflow

Il sistema automatico di ricircolo.

La vasca può avere due tipi di utilizzo. In quello tradizionale l'acqua arriva appena sopra le bocchette dell'idromassaggio e il ricircolo avviene attraverso una pompa a basso consumo. Nell'utilizzo a sfioro, l'acqua in eccesso si riversa nel vano tecnico alloggiato sotto il cuscino, dove viene purificata e reimpressa nella vasca alla temperatura desiderata. Questo sistema mantiene la vasca sempre piena e pronta all'uso.

The automatic recirculation system.

The bathtub can have two types of use. In normal use, recirculation system is performed by a low-consumption recirculation low consumption pump. In overflow use, the excess water is filed into the technical tank, where it is purified and returned to the bathtub at the desired temperature. This system keeps the bathtub always full and ready for use.

Utilizzo tradizionale della vasca
Normal use of the bathtub

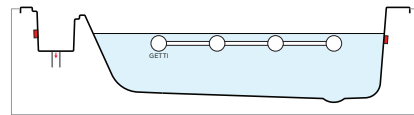

Utilizzo a sfioro della vasca
Use of the bathtub with recirculation system

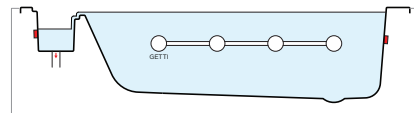

Troppo pieno
Over flow

Alloggiamento per filtro in carta
Position of paper filter

Cassa audio
Audio speakers

Faro cromoterapia
Chromotherapy lamp

Sensore di livello meccanico
Mechanical water level sensor

Piletta di scarico per riciclo acqua
Drain trap for water recirculation

Componentistica vano tecnico
All components inside the technical area



In qualsiasi momento lo desideri, Minerva è pronta ad accoglierti: il sistema automatico di ricircolo igienizza l'acqua e la reimmette nella vasca, consentendone un utilizzo continuo, senza necessità di svuotarla quotidianamente. Inoltre, tramite il tastierino digitale, è possibile controllare le impostazioni della temperatura perché al momento dell'uso sia esattamente come la si desidera. Completa di impianto di disinfezione UV di serie, cromoterapia e accessorio audio Bluetooth, questa vasca può essere utilizzata come un idromassaggio tradizionale oppure può essere riempita con un effetto a sfioro, grazie ad un sistema che mantiene sempre costante il livello dell'acqua. Per una sensazione di benessere avvolgente e completa.

At any time you wish, Minerva is ready to welcome you: the automatic recirculation system keeps the water always purified and at the perfect temperature. A whirlpool bath complete with standard UV disinfection system, chromotherapy and optional Bluetooth audio, which can be used normally or completely filled with an infinity effect, for a feeling of enveloping and complete wellbeing.

Minerva outdoor

collection



DIMENSIONI
200x150 cm

CARATTERISTICHE
vasca con troppo
pieno a sfioro

DIMENSIONS
200x150 cm

SPECIFICATIONS
tub with 'infinity'
overflow

Minerva indoor

Caratteristiche tecniche Technical details

DIMENSIONI

215x150 cm
200x150 cm

CARATTERISTICHE

Realizzata in acrilico con rinforzo in vetroresina
Disponibile pannellata nei colori laccati opaco, lucido o ecomalta
Posizionamento free standing, angolo, parete o ad incasso

COME FUNZIONA

Il troppo pieno è dato da una fessura 4 cm più bassa rispetto al bordo vasca posizionato sotto la copertura del serbatoio

Si hanno quindi 2 versioni: nella prima l'acqua che va in sfioro nel troppo pieno viene direttamente scaricata; nella versione con sistema automatico di riciclo l'acqua che raggiunge il troppo pieno viene ricaricata nella vasca

Sistemi whirlpool - airpool - whirlpool airpool
Sistema di ricircolo, filtro, riscaldatore e cromoterapia

MEASUREMENT

215x150 cm
200x150 cm

SPECIFICATIONS

Material Acrylic Tub with fibreglass reinforcement
Can be panelled (available in matt, glossy lacquered colours or in eco-cement)
Positioning free-standing, corner, wall, built-in

HOW IT WORKS

The overflow is in the form of a slit that is 4 cm lower than the edge of the tub, located under the tank cover

There will be 2 versions: the first one is simple, meaning that when the water flows out of the overflow it is immediately emptied; In the version with recirculation system the water that reaches the overflow is fed back into the tub

Systems that can be used are Whirlpool airpool whirlpool airpool
Recirculating system, filter, heater and colour therapy

Minerva outdoor

Caratteristiche tecniche Technical details

DIMENSIONI

200x150 cm

CARATTERISTICHE

Vasca per installazione su verande oppure terrazze con tetto

(la vasca non è dotata di vassoio quindi è necessario un pavimento)

Realizzata in acrilico con rinforzo in vetroresina
Disponibile pannellata in finitura ecomalta

Posizionamento free standing, angolo, parete o ad incasso

Il serbatoio che ha funzione di troppo pieno è coperto da un pannello in ecomalta

COME FUNZIONA

Disponibile solo con sistema automatico di riciclo

MEASUREMENT

200x150 cm

SPECIFICATIONS

Tub designed to be installed on verandas or roofed terraces (it's important that there is a floor as the tub does not have a tray)

Material Acrylic Tub with fibreglass reinforcement
Can be panelled (available in eco-cement)
Positioning free-standing, corner, wall, built-in

The tank for the overflow water is covered by an eco-cement panel

HOW IT WORKS

Available with recirculation system only

Misure disponibili / Available sizes

200x150 cm

215x150 cm

Parete
Wall

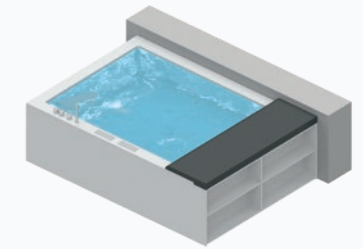
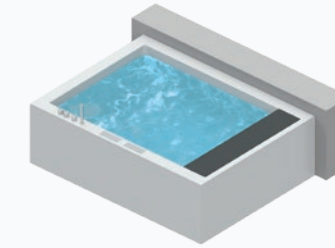

Angolo
Corner

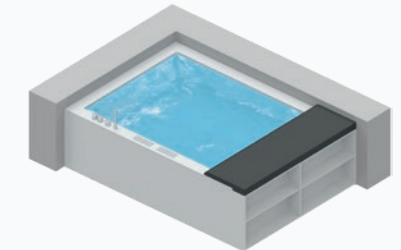
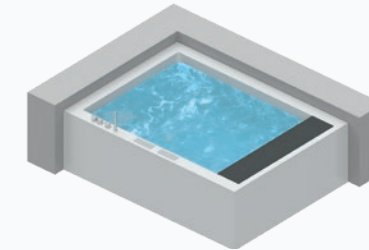

Nicchia
Niche

Per vano tecnico consultare scheda tecnica
For the inspection area pls check the technical data sheet

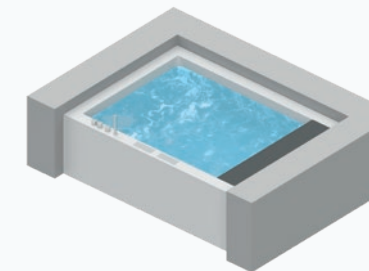

Freestanding

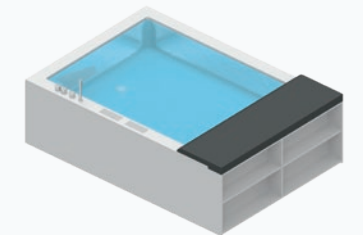
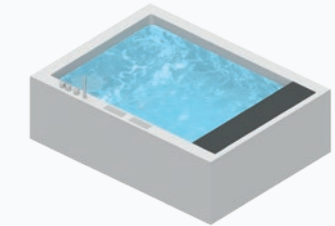

Incasso
Built-in

Per vano tecnico consultare scheda tecnica
For the inspection area pls check the technical data sheet

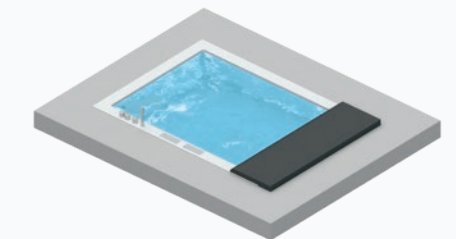
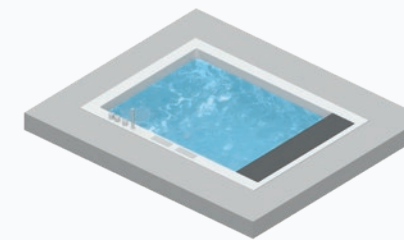

Accessori Minerva Minerva accessories

RUBINETTERIA "PRESTIGE" MINERVA INDOOR

Rubinetteria Prestige A2 quattro fori.
Rubinetteria Prestige B2 quattro fori
con bocca erogazione.

"PRESTIGE" TAPS MINERVA INDOOR

*Prestige A2 - 4 holes tap.
Prestige B2 - 4 holes tap
with water spout.*



Prestige A2

Prestige B2

RUBINETTERIA TERMOSTATICA MINERVA OUTDOOR

Miscelatore termostatico a 1 + 5 vie.
Solo per installazione a muro.

THERMOSTATIC TAP MINERVA OUTDOOR

*1 + 5 ways thermostatic mixer.
Only for wall installation.*



COPERTURA TERMICA in Ecopelle Antracite per Minerva outdoor 200x150

Copertura termica per la protezione da
elementi esterni che involontariamente
possono finire all'interno della vasca.
Tale copertura manterrà il calore
dell'acqua, sia nei periodi estivi
che nei periodi invernali. Esclude
rubinetteria bordo vasca.

THERMAL COVER in anthracite eco-leather for outdoor Minerva 200 x 150

*Thermal cover for protection from
external elements that can involuntarily
end up inside the bathtub.
Thermal cover will maintain the warmth
of the water, both in summer and in
winter. Tub mounted taps can not be
installed with thermal cover.*

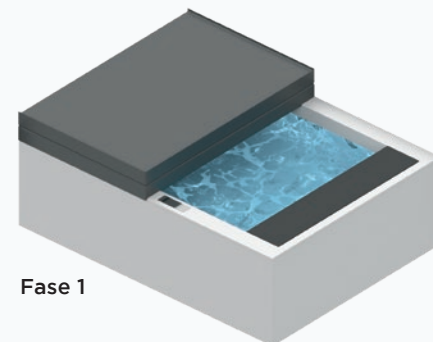

Fase 1

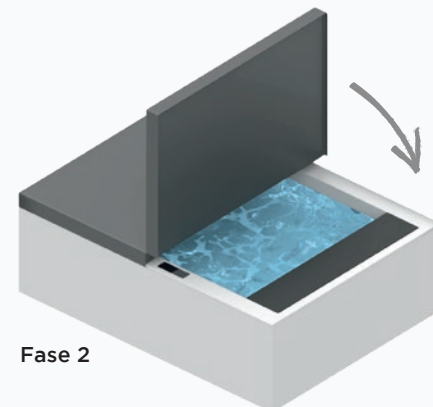

Fase 2



TASTIERE DAL DESIGN MINIMAL ED ELEGANTE

CONTROLS PANELS WITH A MINIMAL AND ELEGANT DESIGN

Tastiera touch per sistema whirlpool airpool con ricircolo automatico dell'acqua
Touch control for whirlpool airpool with water recirculation system



Tastiera touch funzione audio-musica, optional solo per sistema whirlpool
airpool con ricircolo automatico dell'acqua
*Touch control for the audio system, optional only for whirlpool airpool system
with water recirculation system*



Tastiera digitale per sistema whirlpool
Digital control for whirlpool system



Tastiera digitale per sistema airpool
Digital control for airpool system



Tastiera digitale per sistema whirlpool airpool
Digital control for whirlpool airpool system



BOLLA

design FRANCO BERTOLI

Bolla è una collezione completa e versatile di vasche idromassaggio, anche a sfioro: rotonde, rettangolari e quadrate di diverse dimensioni, in versione freestanding o con quattro modalità di incasso. Un bagno nella vasca idromassaggio Bolla è ancora più piacevole e benefico se la vasca è equipaggiata con cuscino poggiatesta, riscaldatore che mantiene l'acqua a una temperatura costante e faro per la cromoterapia.

Bolla is a complete and versatile collection of whirlpool tubs, also with everflow rim: round, rectangular and square of different sizes, in freestanding version or with different types for built in installation. A bath in Bolla is even more pleasant and beneficial if the tub is equipped with headrest, heater that keeps water at a constant temperature and chromotherapy lamps.

**Una vasca idromassaggio intelligente,
dotata di sistemi digitali e funzionalità all'avanguardia.**

*An intelligent whirlpool, equipped with digital
systems and cutting-edge features.*

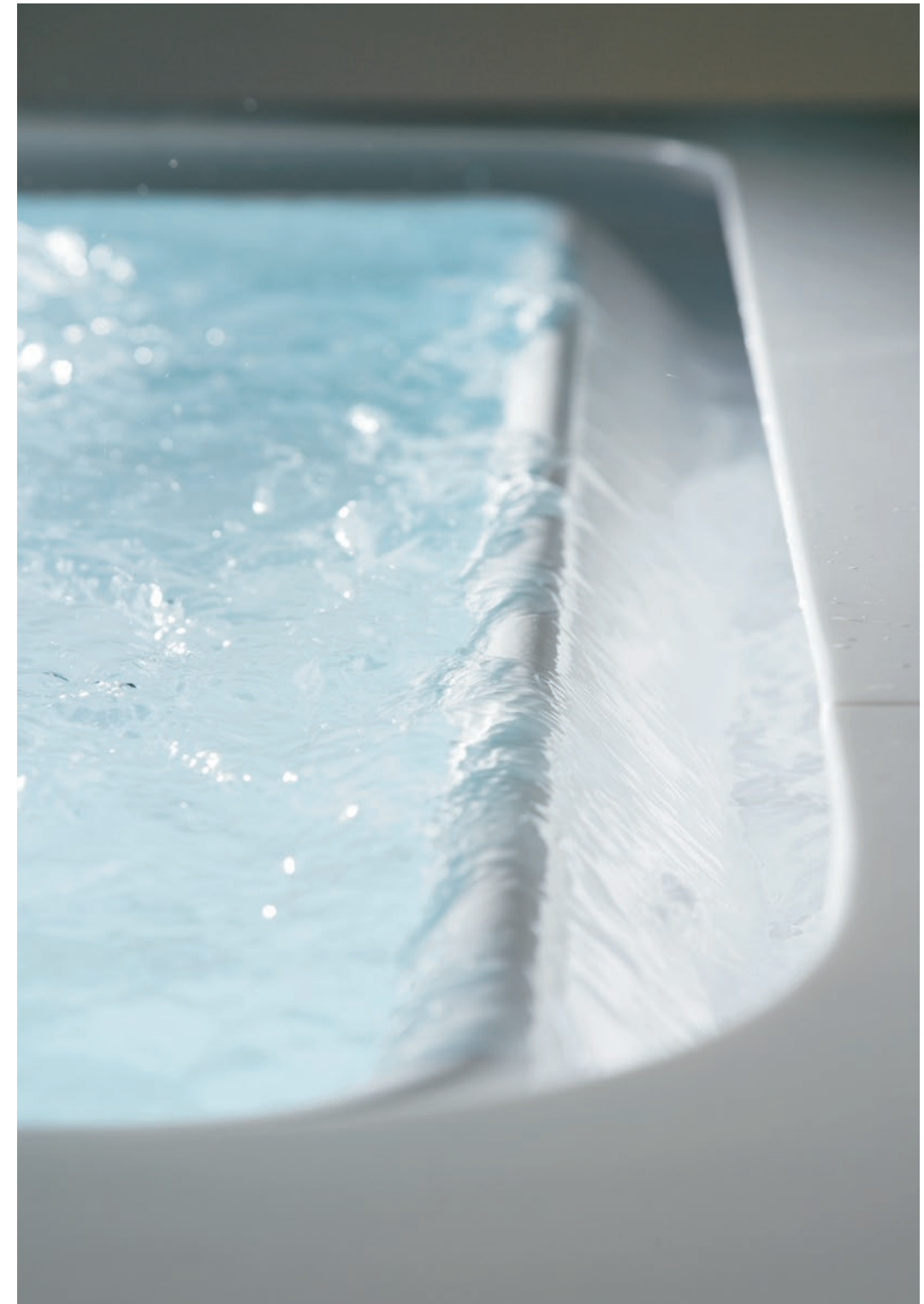

Bolla Q SFIORO

design

Franco Bertoli

DIMENSIONI

190x190 cm Airpool
con sistema automatico di ricircolo

CARATTERISTICHE

sistema automatico di ricircolo
vasca digitale airpool
24 iniettori airpool
massaggio microdiffuso
con elettrosffiante
a velocità regolabile
cromoterapia (optional)
air clean system
riscaldatore
ozonoterapia
sistema disinfezione Biosan
piletta di scarico
sifone scarico
colonna di scarico
a vasi comunicanti
sensore di livello
faro subacqueo
programma pulsato

DIMENSIONS

190x190 cm Airpool
with water recirculation system

SPECIFICATIONS

automatic water
purification system
airpool digital bathtub
24 Airpool jets
micro-diffused massage
by electro-blower
with adjustable speed
colour therapy (optional)
air clean system
heater
ozone therapy
Biosan disinfection system
drain column
trap drain
overflow column
with communicating vessels
level sensor
underwater light
airpool pulsed program



Bolla Q SFIORO

design
Franco Bertoli



DIMENSIONI
190x190 cm

DIMENSIONS
190x190 cm



Bolla^R SFIORO

design
Franco Bertoli / Davide Danielli

DIMENSIONI

200x150 cm Airpool

CARATTERISTICHE

vasca digitale airpool
24 Iniettori airpool
massaggio microdiffuso
con elettrosoffiante
a velocità regolabile
cromoterapia (optional)
air clean system
programma pulsato
sensore di livello
faro subacqueo
sistema disinfezione
pielletta di scarico
sifone scarico

DIMENSIONS

200x150 cm Airpool

SPECIFICATIONS

airpool digital bathtub
24 Airpool jets
micro-diffused massage
by electro-blower
with adjustable speed
colour therapy (optional)
air clean system
pulsed program
level sensor
underwater light
underwater light
drain column
trap drain

Bolla SFIORO Ø190

design
Franco Bertoli / Davide Danielli

DIMENSIONI

Ø 190 cm Airpool

CARATTERISTICHE

vasca digitale airpool
24 iniettori airpool
programma pulsato
massaggio microdiffuso
con elettrosoffiante
a velocità regolabile
cromoterapia (optional)
faro subacqueo
air clean system
sensore di livello
piletta di scarico
colonna di scarico
sifone scarico
ozonoterapia
sistema disinfezione biosan

DIMENSIONS

Ø 190 cm Airpool

SPECIFICATIONS

airpool digital bathtub
24 Airpool jets
pulsed program
micro-diffused massage
by electro-blower with
adjustable speed
colour therapy (optional)
underwater light spot
air clean system
level sensor
trap plastic drain
overflow column
drain column
ozone therapy
biosan disinfection system



Bolla SFIORO Ø190

design

Franco Bertoli / Davide Danielli

Bolla è l'esito creativo di un design d'avanguardia, sviluppato coniugando tecnica, ergonomia ed estetica. La forma consente un volume eccezionale d'acqua. Il sistema di igienizzazione permette di utilizzarla a lungo, sempre pronta, sempre pulita, sempre con la temperatura giusta grazie ad un sistema automatico di ricircolo acqua con controllo di temperatura e disinfezione.

Il concept si sviluppa in una linea completa con le versioni a sfioro free standing o con quattro modalità di incasso.

Bolla is the imaginative result of an avant-garde design, born by technique, ergonomics and aesthetics. Its shape contains an exceptional volume of water. The disinfection system grant the use of it for a long time, always ready, always clean, always with the right temperature thanks to an automatic water recirculation system with control temperature and disinfection. The concept develops in a complete line with free-standing infinity versions or with four ways of collection.

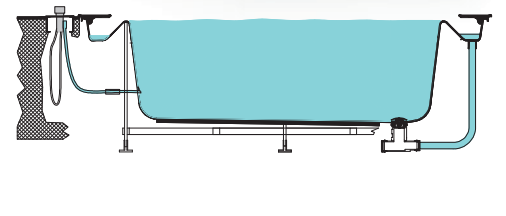
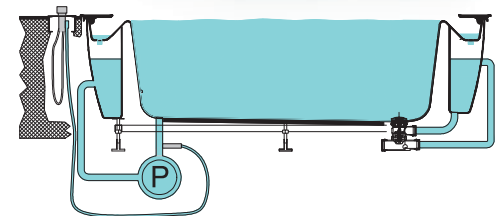

Versione Airpool con sistema con serbatoio integrato per il ricircolo dell'acqua.

Airpool version with integrated water tank governing water purification system.

Versione Airpool, Whirlpool e Whirlpool Airpool senza sistema di ricircolo dell'acqua.

Airpool, Whirlpool and Whirlpool Airpool without water purification system.



**Una finitura materica
per un ambiente moderno.**

*Material finishing, for a
contemporary ambience.*

Bolla SFIORO Ø190

*design
Franco Bertoli / Davide Danielli*

La resina, unita a miscele minerali,
garantisce elevate prestazioni
tecniche, ideali per ogni utilizzo.

*The resin, combined with mineral
mixtures, guarantees high technical
performance, ideal for every use.*

DIMENSIONI
Ø 190 cm Airpool

DIMENSIONS
Ø 190 cm Airpool

Bolla SFIORO Ø190

design
Franco Bertoli / Davide Danielli



DIMENSIONI
Ø 190 cm Airpool

DIMENSIONS
Ø 190 cm Airpool

Bolla Ø160

design
Franco Bertoli / Davide Danielli

DIMENSIONI

Ø 160 cm Airpool

CARATTERISTICHE

vasca digitale airpool
24 iniettori airpool
programma pulsato
massaggio microdiffuso
con elettrosoffiante
a velocità regolabile
faro subacqueo
air clean system
sensore di livello
colonna di scarico
a vasi comunicanti
sifone scarico

DIMENSIONS

Ø 160 cm Airpool

SPECIFICATIONS

airpool digital bathtub
24 Airpool jets
airpool pulsed program
micro-diffused massage
by electro-blower with
adjustable speed
underwater light
air clean system
level sensor
overflow column
with communicating vessels
trap drain



Bolla Q 160X160

design
Franco Bertoli

DIMENSIONI

160x160 cm Airpool

CARATTERISTICHE

vasca digitale airpool
24 iniettori airpool
massaggio microdiffuso
con elettrosffiante
a velocità regolabile
cromoterapia (optional)
air clean system
sensore di livello
sistema disinfezione (optional)
piletta di scarico
sifone scarico
colonna di scarico
a vasi comunicanti
programma pulsato

DIMENSIONS

160x160 cm Airpool

SPECIFICATIONS

airpool digital bathtub
24 Airpool jets
micro-diffused massage
by electro-blower with
adjustable speed
colour therapy (optional)
air clean system
level sensor
drain column
disinfection system (optional)
trap drain
overflow column
with communicating vessels
pulsed program



Vasca da incasso con sistema
idromassaggio Airpool, spaziosa
ma di dimensioni contenute.

Square built-in tub, Airpool system,
wide but smaller than the 190one.

Bolla R 162

design
Franco Bertoli / Davide Danielli

Vasca da incasso di dimensioni contenute,
per adattarsi ad ogni spazio.

*Built in tub, minimum amount of space,
suitable for every room.*

DIMENSIONI

162x112 cm Airpool

CARATTERISTICHE

vasca digitale airpool
24 iniettori airpool
massaggio microdiffuso
con elettrosoffiante
a velocità regolabile
air clean system
sensore di livello
sifone scarico
colonna di scarico
a vasi comunicanti
programma pulsato
faro subacqueo

DIMENSIONS

162x112 cm Airpool

SPECIFICATIONS

airpool digital bathtub
24 Airpool jets
micro-diffused massage
by electro-blower with
adjustable speed
air clean system
level sensor
trap drain
overflow column
with communicating vessels
pulsed program
underwater light



Bolla

Caratteristiche tecniche Technical details

INSTALLAZIONE

La naturalezza dell'acqua ispira una linea completa di vasche progettata nella versione a sfioro da 190Ø / 190Q / R200 freestanding o con quattro modalità di incasso.

INSTALLATION

Elegance of water inspires a complete line of tubs: sfioro edge, 190Ø / 190Q / R200 in the freestanding version or with four different way of built-in installation.

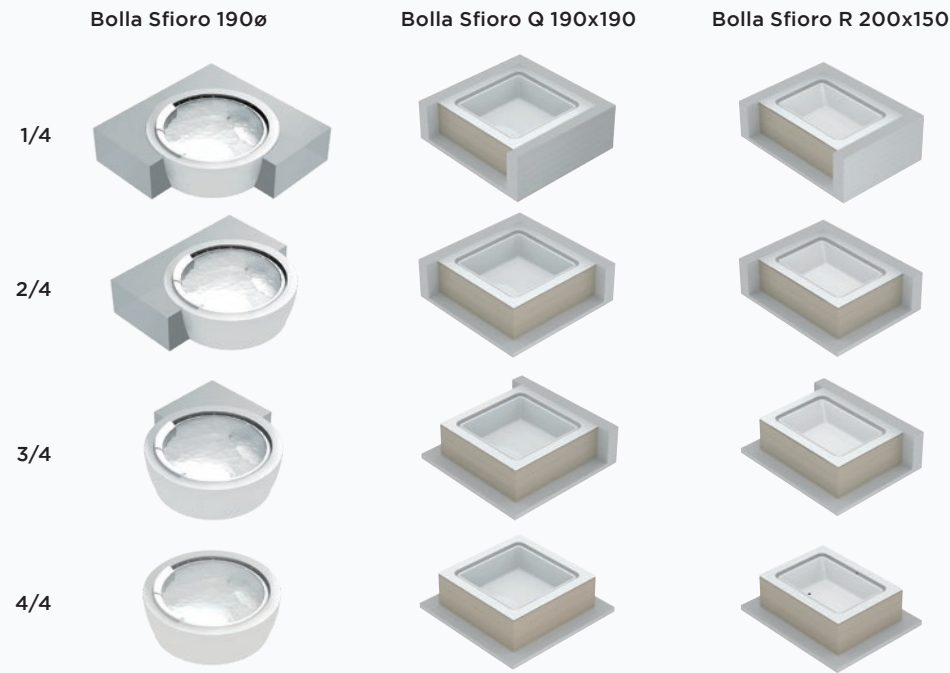

TASTIERA DIGITALE PER BOLLA CON RICIRCOLO DELL'ACQUA

Dopo l'accensione con il tasto installato nella vasca, tutte le funzioni si controllano comodamente mediante un telecomando.

DIGITAL KEYPAD FOR BOLLA WITH WATER PURIFICATION SYSTEM

Switch on pressing key built in the tub: every function can be easily controlled using hi-tech remote control.

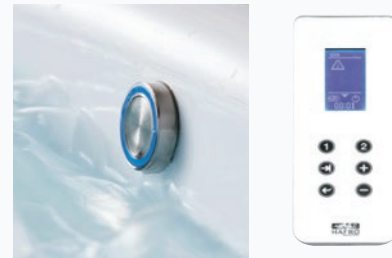

TASTIERA DIGITALE PER BOLLA SENZA RICIRCOLO DELL'ACQUA

Le funzioni di idromassaggio della versione senza ricircolo d'acqua si attivano direttamente dalla vasca attraverso un tastiera digitale.

DIGITAL KEYPAD FOR BOLLA WITH WATER PURIFICATION SYSTEM

The hydromassage functions, on versions without water purification systems, can be directly activated from the tub itself, using digital keypad.

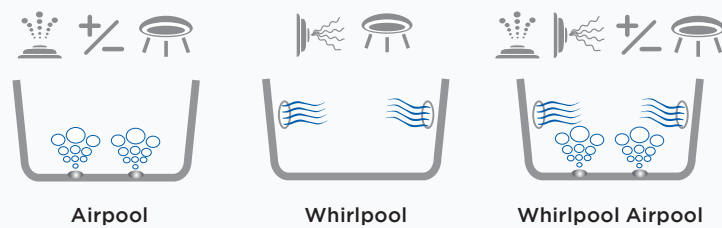

Airpool

Whirlpool

Whirlpool Airpool

RUBINETTERIA TAPS

Modelli _ Bolla Sfiore - Bolla con E.T.P.

Models_ Bolla Sfiore - Bolla with water filling from overflow

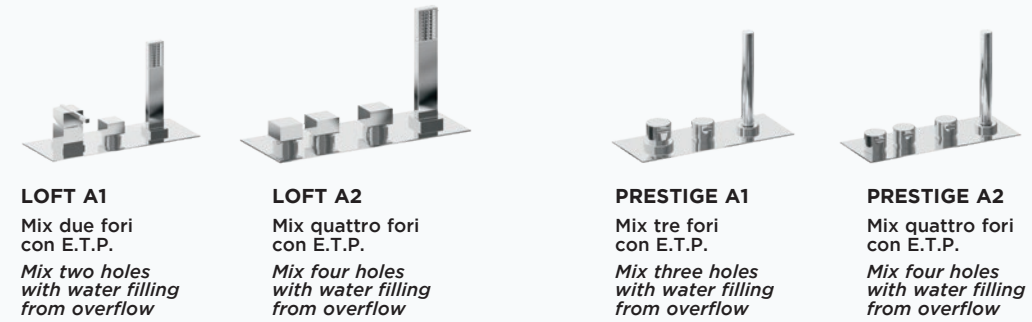

LOFT A1

Mix due fori con E.T.P.
Mix two holes with water filling from overflow

LOFT A2

Mix quattro fori con E.T.P.
Mix four holes with water filling from overflow

PRESTIGE A1

Mix tre fori con E.T.P.
Mix three holes with water filling from overflow

PRESTIGE A2

Mix quattro fori con E.T.P.
Mix four holes with water filling from overflow



PIANTANA Pedestal

Modelli _ Bolla Ø 160, Bolla R 162x112, Bolla Q 160

Models_ Bolla Ø 160, Bolla R 162x112, Bolla Q 160

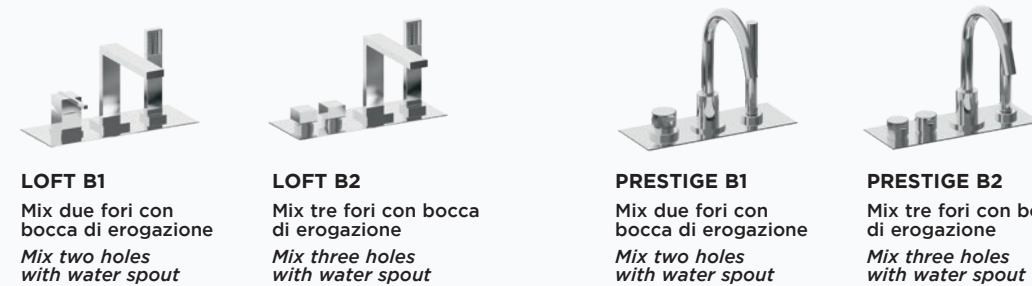

LOFT B1

Mix due fori con bocca di erogazione
Mix two holes with water spout

LOFT B2

Mix tre fori con bocca di erogazione
Mix three holes with water spout

PRESTIGE B1

Mix due fori con bocca di erogazione
Mix two holes with water spout

PRESTIGE B2

Mix tre fori con bocca di erogazione
Mix three holes with water spout

FINITURE PANNELLI PANELS FINISHES

Bolla Sfiore Ø 190 versione tonda
Bolla Sfiore Ø 190 round version

di serie

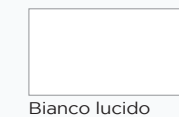

Bianco lucido

optional Ecomalta

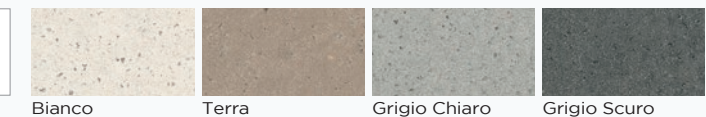

Bianco

Terra

Grigio Chiaro

Grigio Scuro

Bolla Sfiore Q 190 Bolla Sfiore R 200x150 versione quadrata e rettangolare

Bolla Sfiore Q 190 Bolla Sfiore R 200x150 square and rectangular version

di serie



Solid Surface

optional Fenix



Grigio Efeso

Grigio Bromo

Grigio Londra

FOR ALL

design FRANCO BERTOLI

**Vasca idromassaggio
con porta battente per chi cerca
la comodità nel quotidiano.**

*Hydromassage tub with hinged door
for comfort in everyday life.*



HAFRO
acqua, per piacere

For All

*design
Franco Bertoli*

DIMENSIONI

180x78/83 sx angolo

CARATTERISTICHE

vasca whirlpool airpool
chiusura (con porta battente)
in cristallo di sicurezza
12 iniettori airpool
8 getti whirlpool
faro subacqueo
air clean system
massaggio microdiffuso
elettrosoffiante a velocità regolabile
igienizzazione impianto whirlpool
sensore di livello
colonna di scarico
sifone scarico
programma pulsato

DIMENSIONS

180x78/83 LH corner

SPECIFICATIONS

*whirlpool airpool tubs
crystal glass shutter door
12 airpool jets
8 whirlpool jets
underwater light
air clean system
micro-diffused massage electric-blower
with adjustable speed
whirlpool disinfection system
level sensor
drain column
trap drain
pulsed program*



MODE

collection

Le vasche Mode, dalle linee accattivanti ma dalle dimensioni ottimali, sono pratiche e funzionali. Nella versione Mode 190x80 la pannellatura è dotata di pratici vani porta oggetti.

The Mode bathtubs have enticing lines and optimal dimensions. Practical and functional. Panels are customized in RAL selection, on the shorter side, in bigger versions there are also 2 holding shelves.

Misure disponibili
Available sizes

190x80 180x90 170x80 180x75 160x90/70



DIMENSIONI
190x80 cm

DIMENSIONS
190x80 cm

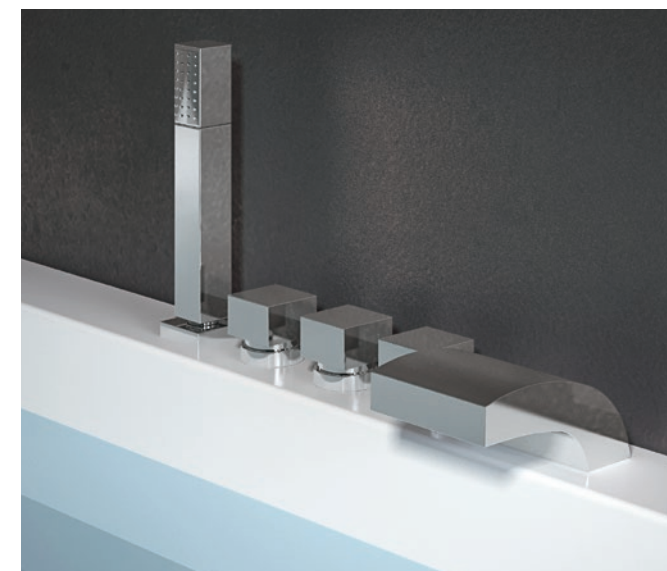

Mode

collection

DIMENSIONI

180x90 cm

CARATTERISTICHE

vasca digitale whirlpool
8 getti whirlpool
igienizzazione impianto whirlpool
faro subacqueo
colonna scarico
sifone scarico
sensore di livello
programma pulsato
massaggio microdiffuso
con elettrosffiante
a velocità regolabile
air clean system

DIMENSIONS

180x90 cm

SPECIFICATIONS

digital whirlpool bath
8 whirlpool jets
whirlpool disinfection system
underwater spotlight
drain pipe with trap
trap drain
level sensor
airpool pulsed program
micro-diffused massage
by electro-blower with
adjustable speed
air clean system



180x90 cm digitale DX _ RH digital



180x75 cm airpool SX _ LH airpool

DIMENSIONI
180x75 cm

CARATTERISTICHE
vasca digitale airpool
16 iniettori airpool
programma pulsato
massaggio
microdiffuso con
elettrosoffiante
a velocità regolabile

faro subacqueo
air clean system
sensore di livello
colonna scarico
sifone scarico

DIMENSIONS
180x75 cm

SPECIFICATIONS
airpool digital
bathtub
16 airpool jets
airpool pulsed
program

*micro-diffused massage
by electro-blower with
adjustable speed
underwater light
air clean system
level sensor
overflow column
trap drain*



160x90/70 cm airpool DX _ RH airpool

DIMENSIONI
160x90/70 cm

CARATTERISTICHE
vasca digitale airpool
16 iniettori airpool
programma pulsato

massaggio
microdiffuso con
elettrosoffiante
a velocità regolabile
faro subacqueo
air clean system
sensore di livello
colonna scarico
sifone scarico

DIMENSIONS
160x90/70 cm

SPECIFICATIONS
airpool digital
bathtub
16 airpool jets
airpool pulsed
program

*micro-diffused massage
by electro-blower with
adjustable speed
underwater light
air clean system
level sensor
overflow column
trap drain*

ERA^{PLUS} - ERA

collection

Design e dimensioni diverse: le vasche idromassaggio Era si adattano ad ogni spazio e riservano un'esperienza totale di comfort, che unisce alla tecnologia whirlpool ed airpool i benefici della cromoterapia e dell'ozonoterapia.

Il comodo cuscino Life completa lo stile e la comodità.

Disponibile anche in finitura Acrilico opaco, esclusa Era 140x140.

Design and different dimensions: Era hydromassage tubs adapt to any space and reserve a total comfort experience, which combines whirlpool and airpool technology with the benefits of color therapy and ozone therapy.

The comfortable Life pillow completes style and comfort.

Also available in matt Acrylic finish, excluding Era 140x140.

Il benessere si esprime in tante forme.

Wellness in many forms.



Era plus

collection

Disponibile anche in finitura Acrilico opaco
Also available in matt Acrylic finish

DIMENSIONI

200x120 cm

CARATTERISTICHE

professional whirlpool
airpool - incasso
vasca digitale
8 getti whirlpool
24 iniettori airpool
intensità idromassaggio
whirlpool regolabile
programma pulsato airpool
massaggio microdiffuso
con elettrosffiante a
velocità regolabile
ozonoterapia con
riscaldatore e regolazione
della temperatura
air clean system
igienizzazione impianto
whirlpool
faro subacqueo
sensore di livello
colonna scarico
sifone scarico

DIMENSIONS

200x120 cm

SPECIFICATIONS

professional whirlpool
airpool - built-in
digital bathtub
8 whirlpool jets
whirlpool
24 airpool jets
adjustable whirlpool
hydromassage intensity
pulsed airpool program
micro-diffused massage
by electro-blower with
adjustable speed
ozonotherapy with heater
and temperature regulation
air clean system
disinfection system
underwater light
level sensor
drain column
trap drain



**DIMENSIONI**
200x120 cm

CARATTERISTICHE
vasca digitale
8 getti whirlpool
igienizzazione
impianto whirlpool
faro subacqueo
sensore di livello
colonna scarico
sifone scarico

DIMENSIONS
200x120 cm

SPECIFICATIONS
digital bathtub
8 whirlpool jets
whirlpool
disinfection system
underwater light
level sensor
drain column
trap drain

**DIMENSIONI**
180x120/70 cm

CARATTERISTICHE
vasca digitale
8 getti whirlpool
igienizzazione
impianto whirlpool
faro subacqueo
sensore di livello
colonna scarico
sifone scarico

DIMENSIONS
180x120/70 cm

SPECIFICATIONS
digital bathtub
8 whirlpool jets
whirlpool
disinfection system
underwater light
level sensor
drain column
trap drain

Era

collection

Non disponibile in finitura
Acrilico opaco
Not available in matt
Acrylic finish



140x140 cm airpool

DIMENSIONI

140x140 cm

CARATTERISTICHE

vasca digitale airpool
16 iniettori airpool
programma
pulsato airpool
massaggio
microdiffuso con
elettrosoffiante a
velocità regolabile

faro subacqueo
air clean system
sensore di livello
colonna scarico
sifone scarico

DIMENSIONS

140x140 cm

SPECIFICATIONS

airpool bathtub
16 airpool jets
airpool pulsed program
micro-diffused
massage
electro-blower with
adjustable speed
underwater light

air clean system
level sensor
drain column
trap drain

Era plus

collection

Disponibile anche in finitura
Acrilico opaco
Also available in matt
Acrylic finish



190x90 cm
professional whirlpool airpool

DIMENSIONI

190x90 cm
professional whirlpool
airpool

CARATTERISTICHE

professional whirlpool
airpool - incasso
vasca digitale
8 getti whirlpool
24 iniettori airpool
intensità idromassaggio
whirlpool regolabile
programma pulsato
airpool

massaggio microdiffuso
con elettrosoffiante
a velocità regolabile
ozonoterapia con
riscaldatore e
regolazione della
temperatura
air clean system
igienizzazione
impianto whirlpool
faro subacqueo
sensore di livello
colonna scarico
sifone scarico

DIMENSIONS

190x90 cm
professional whirlpool
airpool

SPECIFICATIONS

professional whirlpool
airpool - built-in
digital bathtub
8 whirlpool jets
whirlpool
24 airpool jets
adjustable whirlpool
hydromassage
intensity

pulsed airpool program
micro-diffused
massage
by electro-blower with
adjustable speed
ozonotherapy
with heater and
temperature regulation
air clean system
disinfection system
underwater light
level sensor
drain column
trap drain

EVA

collection

Il design lineare e moderno di Eva si arricchisce di tante funzionalità pensate per offrire il massimo del benessere a corpo e mente.

La vasca può essere personalizzata con pannelli di diverse finiture e colori.

The linear and modern design of Eva is enriched with many features designed to offer maximum well-being to body and mind. The bathtub can be customized with side panels in different finishes and colors.

**Piccoli mondi in cui abbandonarsi
al relax per rigenerarsi.**

*Different ways in which to indulge
in relaxation to regenerate.*



Eva

collection

DIMENSIONI

180x80 cm sx

CARATTERISTICHE

vasca digitale airpool
16 iniettori airpool
programma
pulsato airpool
massaggio microdiffuso
con elettrosoffiante a
velocità regolabile
faro subacqueo
air clean system
sensore di livello
colonna scarico
sifone scarico

DIMENSIONS

180x80 cm left

SPECIFICATIONS

airpool bathtub
16 airpool jets
airpool pulsed program
micro-diffused massage
electro-blower with
adjustable speed
underwater light
air clean system
level sensor
drain column
trap drain



Eva

collection

DIMENSIONI

170x70 cm

CARATTERISTICHE

vasca digitale airpool
16 iniettori airpool
programma pulsato
massaggio microdiffuso
con elettrosffiante a
velocità regolabile
faro subacqueo
air clean system
sensore di livello
colonna scarico
sifone scarico in plastica

DIMENSIONS

170x70 cm

SPECIFICATIONS

airpool digital
bathtub
16 airpool jets
pulsed program
micro-diffused massage
by electro-blower with
adjustable speed
underwater light
air clean system
level sensor
drain column
trap plastic drain



Zaphiro

collection

200x100 cm digitale _ *digital*

DIMENSIONI
200x100 cm

SISTEMI
whirlpool
digitale
airpool
whirlpool / airpool
professional
whirlpool / airpool

CARATTERISTICHE
vasca digitale
6 getti whirlpool
igienizzazione
impianto whirlpool
faro subacqueo
sensore di livello
sifone scarico
colonna di scarico

DIMENSIONS
200x100 cm

SYSTEM
whirlpool
digital
airpool
whirlpool / airpool
professional
whirlpool / airpool

SPECIFICATIONS
digital bathtub
6 whirlpool jets
whirlpool
disinfection system
underwater light
level sensor
trap drain
overflow column with
communicating vessels

Oasy

collection



195x115 cm airpool

DIMENSIONI
195x115 cm

SISTEMI
whirlpool
digitale
airpool
whirlpool / airpool
professional
whirlpool / airpool

CARATTERISTICHE
vasca airpool
20 iniettori airpool
faro subacqueo
sensore di livello
sifone
colonna di scarico

DIMENSIONS
195x115 cm

SYSTEM
whirlpool
digital
airpool
whirlpool / airpool
professional
whirlpool / airpool

SPECIFICATIONS
airpool bathtub
20 airpool jets
underwater light
level sensor
drain
overflow column

Duo

collection



170x65/78 cm a parete _ wall

DIMENSIONI

170x65/78 cm

SISTEMI

whirlpool
digitale
airpool
whirlpool airpool

CARATTERISTICHE

vasca con telaio
colonna scarico
sifone scarico

DIMENSIONS

170x65/78 cm

SYSTEM

whirlpool
digitale
airpool
whirlpool airpool

SPECIFICATIONS

bathtub with
supporting frame
overflow column
trap drain

Ondaria

collection



180x80 cm airpool a parete _ wall

DIMENSIONI

180x80 _ 170x70/75 cm

SISTEMI

whirlpool
digitale
airpool
whirlpool airpool
professional
whirlpool airpool

CARATTERISTICHE

vasca digitale airpool
12 iniettori airpool
programma pulsato
massaggio microdiffuso
con elettrosoffiante a
velocità regolabile
faro subacqueo
air clean system
sensore di livello
colonna scarico
sifone scarico

DIMENSIONI

180x80 _ 170x70/75 cm

SISTEMI

whirlpool
digitale
airpool
whirlpool airpool
professional
whirlpool airpool

CARATTERISTICHE

airpool digital bathtub
12 airpool jets
pulsed program
micro-diffused massage
by electroblower with
adjustable speed
underwater light spot
air clean system
level sensor
overflow column
trap drain

Gamma

collection



170x70/76 cm digitale ad incasso SX _ digital built-in LH

DIMENSIONI
170x70/76 cm

SISTEMI
whirlpool
digitale
airpool
whirlpool airpool
professional
whirlpool airpool

CARATTERISTICHE

vasca digitale
6 getti whirlpool
igienizzazione
sistema whirlpool
faro subacqueo
sensore di livello
colonna scarico
sifone scarico

DIMENSIONS
170x70/76 cm

SYSTEM
whirlpool
digitale
airpool
whirlpool airpool
professional
whirlpool airpool

SPECIFICATIONS

digital bathtub
6 whirlpool jets
whirlpool
disinfection system
underwater light
level sensor
overflow column
trap drain

Igloo

collection



160x60 cm whirlpool-airpool

DIMENSIONI
160x160 cm

SISTEMI
whirlpool
digitale
airpool
whirlpool airpool
professional
whirlpool airpool

CARATTERISTICHE

vasca digitale
8 getti whirlpool
15 iniettori airpool
programma pulsato
massaggio microdiffuso
con elettrosoffiante a
velocità regolabile
igieniz. impianto whirlpool
air clean system
faro subacqueo
sensore di livello
colonna scarico
sifone scarico

DIMENSIONI
160x160 cm

SISTEMI
whirlpool
digitale
airpool
whirlpool airpool
professional
whirlpool airpool

CARATTERISTICHE

digital bathtub
8 whirlpool jets
15 airpool jets
pulsed program
micro-diffused massage
by electro-blower with
adjustable speed
whirlpool disinfection system
air clean system
underwater light
level sensor
overflow column
trap drain

Ego
collection



150x150 cm airpool

EGO | collection

DIMENSIONI
150x150 cm

SISTEMI
whirlpool
digitale
airpool
whirlpool airpool
professional
whirlpool airpool

CARATTERISTICHE

vasca digitale airpool
20 iniettori airpool
programma pulsato
massaggio microdiffuso
con elettrosoffiante
a velocità regolabile
faro subacqueo
air clean system
sensore di livello
colonna scarico
sifone scarico

DIMENSIONS
150x150 cm left

SYSTEM
whirlpool
digitale
airpool
whirlpool airpool
professional
whirlpool airpool

SPECIFICATIONS

airpool digital bathtub
20 airpool jets
pulsed program
micro-diffused massage
by electro-blower with
adjustable speed
underwater light spot
air clean system
level sensor
overflow column
trap drain

Diva
collection



140x140 cm airpool

DIVA | collection

DIMENSIONI
140x140 cm

SISTEMI
whirlpool
digitale
airpool
whirlpool airpool
professional
whirlpool airpool

CARATTERISTICHE

vasca digitale airpool
12 iniettori airpool
programma pulsato
massaggio microdiffuso
con elettrosoffiante
a velocità regolabile
air clean system
faro subacqueo
sensore di livello
colonna scarico
sifone scarico

DIMENSIONI
140x140 cm

SISTEMI
whirlpool
digitale
airpool
whirlpool airpool
professional
whirlpool airpool

CARATTERISTICHE

digital airpool bathtub
12 airpool jets
pulsed program
micro-diffused massage
by electro-blower with
adjustable speed
air clean system
underwater light spot
level sensor
overflow column
trap drain

Nova

collection



NOVA | collection

170x70
whirlpool-airpool

DIMENSIONI

180x80 cm
170x65/70/80 cm
160x65/70 cm
150x70 cm
140x70 cm
(esclusa versione
whirlpool-airpool)
120x70 cm
(escluso
idromassaggio)

SISTEMI

whirlpool
airpool
whirlpool airpool

CARATTERISTICHE

vasca whirlpool digitale
regolazione aria
6 idrogetti
colonna di scarico
sensore di livello
sifone scarico

DIMENSIONS

180x80 cm
170x65/70/80 cm
160x65/70 cm
150x70 cm
140x70 cm
(whirlpool-airpool
excluded version)
120x70 cm
(excluded
hydromassage)

SYSTEM

whirlpool
airpool
whirlpool airpool

SPECIFICATIONS

whirlpool bathtub
air regulation
6 whirlpool jets
drain column
level sensor
trap drain

Nova

collection



NOVA | collection

160x100
whirlpool-airpool SX _ LH

DIMENSIONI

160x100 cm

SISTEMI

whirlpool
airpool
whirlpool airpool

CARATTERISTICHE

vasca whirlpool-airpool
regolazione aria
6 idrogetti
12 iniettori airpool
colonna scarico
sonda di livello
sifone scarico

DIMENSIONS

160x100 cm

SYSTEM

whirlpool
airpool
whirlpool airpool

SPECIFICATIONS

whirlpool-airpool bathtub
air regulation
6 whirlpool jets
12 airpool jets
drain column
level sensor
trap drain

Nova

collection



140x40 cm whirlpool-airpool

DIMENSIONI

140x140 cm
120x120 cm

SISTEMI

whirlpool
airpool
whirlpool airpool

CARATTERISTICHE

vasca digitale
whirlpool airpool
6 idrogetti
12 iniettori airpool
colonna scarico
sonda di livello
sifone scarico

DIMENSIONS

140x140 cm
120x120 cm

SYSTEM

whirlpool
airpool
whirlpool airpool

SPECIFICATIONS

digital bathtub
whirlpool airpool
6 whirlpool jets
12 airpool jets
drain column
level sensor
trap drain

Nova plus

collection



140x40 cm whirlpool-airpool

DIMENSIONI

140x140 cm

SISTEMI

whirlpool
airpool
whirlpool airpool

CARATTERISTICHE

vasca digitale
whirlpool airpool
6 idrogetti
12 iniettori airpool
colonna scarico
sonda di livello
sifone scarico

DIMENSIONS

140x140 cm

SYSTEM

whirlpool
airpool
whirlpool airpool

SPECIFICATIONS

digital bathtub
whirlpool airpool
6 whirlpool jets
12 airpool jets
drain column
level sensor
trap drain

Old Time

collection



170x80 cm

OLD TIME | collection

DIMENSIONI

170x80 cm

CARATTERISTICHE

vasca con piedini
colonna scarico con sifone
piantana a pavimento
gruppo vasca tipo antico
manopola croce

DIMENSIONS

170x80 cm

SPECIFICATIONS

tub with feet
drain column and siphon
pedestal on floor
bath group antique style
with cross knobs

VASCHE COMBIMATE

WASHTUBS WITH CRYSTAL
GLASS SHOWER CABIN

For All box ³⁹⁰

Era Plus box ³⁹²

Duo box ³⁹⁴

Nova box ³⁹⁶

HAFRO
acqua, per piacere

For All box

collection



Vasca combinata
Tubs with cabin



Vasca
Bathtub



Apertura totale per
facilitare l'accesso
Total opening for
easy access

DIMENSIONI

180x78/83 dx-sx

INSTALLAZIONE

angolo

SISTEMI

digitale
airpool
whirlpool airpool

CARATTERISTICHE

vasca whirlpool airpool
chiusura (con porta battente)
in cristallo di sicurezza
12 iniettori airpool
8 getti whirlpool
faro subacqueo
asta doccia con doccetta (optional)
miscelatore a muro (optional)
air clean system
programma pulsato
massaggio microdiffuso
elettrosoffiante a velocità regolabile
igienizzazione impianto whirlpool
sensore di livello
sifone scarico
kit profilo bordo vasca

MEASUREMENT

180x78/83 RH-LH

INSTALLATION

corner

SYSTEM

digitale
airpool
whirlpool airpool

SPECIFICATIONS

whirlpool airpool tub
crystal glass shutter door
12 airpool jets
8 whirlpool jets
underwater light
shower rod with handshower (optional)
mixer tap (optional)
air clean system
pulsed program
micro-diffused massage electric-blower
with adjustable speed
whirlpool disinfection system
level sensor
trap drain
bowl edge profile kit



180x78/83 cm sx whirlpool airpool

Era plus box

collection

DIMENSIONI

ERA BOX

170x70 dx-sx
170x75 dx-sx

ERA PLUS BOX

180x80 dx-sx
190x90 dx-sx
180x120/70 dx-sx

INSTALLAZIONE

angolo-parete

SISTEMI

whirlpool
digitale
airpool
whirlpool airpool
professional
whirlpool airpool
(solo Era Plus Box)

MEASUREMENT

ERA BOX

170x70 rh-lh
170x75 rh-lh

ERA PLUS BOX

180x80 rh-lh
190x90 rh-lh
180x120/70 rh-lh

INSTALLATION

corner-wall

SYSTEM

whirlpool
digital
airpool
whirlpool airpool
professional
whirlpool airpool
(only Era Plus Box)

CARATTERISTICHE

vasca digitale
whirlpool airpool
8 getti whirlpool
12 iniettori airpool
programma pulsato
airpool
massaggio
microdiffuso con
elettrosoffiante a
velocità regolabile
air clean system
ozonoterapia
(optional)
faro subacqueo
box in cristallo
completo di colonna
in acciaio lucido

SPECIFICATIONS

digital bathtub
whirlpool airpool
8 whirlpool jets
12 airpool jets
pulsed airpool
program
micro diffused
massage with
electro-blower with
adjustable speed
air clean system
ozonotherapy
(optional)
underwater light
crystal glass cabin
built-in headshower
thermostatic tap
deviator
spout

soffione incorporato
miscelatore
termostatico
deviatore
erogatore
doccetta raining
igienizzazione
impianto whirlpool
sensore di livello
colonna scarico
sifone scarico

handshower rain
effect

whirlpool
disinfection system
level sensor
drain column
trap drain



190X90 cm sx whirlpool airpool

Duo box

collection

DIMENSIONI
170x65/78 cm

INSTALLAZIONE
angolo

SISTEMI
whirlpool
digitale
airpool
whirlpool airpool

MEASUREMENT
170x65/78 cm

INSTALLATION
corner

SYSTEM
whirlpool
digital
airpool
whirlpool airpool

CARATTERISTICHE
vasca telaio
colonna di scarico
kit profilo bordo vasca
box in cristallo
completo di colonna
attrezzata
miscelatore
asta doccia con
doccetta
deviatore
erogatore
idromassaggio
verticale pulsato 6 getti
sifone scarico

SPECIFICATIONS
frame bathtub
drain column
bowl edge profile kit
shower cabin
complete of
equipped column
mixer
handshower on slide
bar
deviator
spout
6 vertical pulsed jets
trap drain



170x78 cm sx

Nova box

collection

DIMENSIONI

140x70 cm
(solo versione whirlpool)
150x70 cm
160x70 cm
170x80 cm
180x80 cm

INSTALLAZIONE

angolo

SISTEMI

whirlpool
whirlpool airpool

CARATTERISTICHE

vasca digitale whirlpool
6 getti whirlpool
12 iniettori airpool
sonda di livello
colonna di scarico
box in cristallo di
sicurezza con 2 pareti
apribili
sifone scarico
colonna
Quarantacinque C
(optional)

MEASUREMENT

140x70 cm
(only whirlpool version)
150x70 cm
160x70 cm
170x80 cm
180x80 cm

INSTALLATION

corner

SYSTEM

whirlpool
whirlpool airpool

SPECIFICATIONS

digital bathtub
whirlpool
6 whirlpool jets
12 airpool jets
level sensor
drain column
shower cabin made
by safety tempered
glass with 2 opening
doors
trap drain
shower column 45 C
(optional)



180x80 sx whirlpool airpool

Soprasvasca Time

collection

La vasca diventa una pratica doccia con l'aggiunta di pareti fisse o mobili. Puoi scegliere in libertà tra un bagno rilassante o una doccia rigenerante.

Bathtubs become practical showers with the addition of fixed or movable walls. You can choose freely between a relaxing bath or a regenerating shower.



2 porte battente
2 hinged door



parete fissa + porta
fixed side + door



parete fissa
fixed side

RUBINETTERIA FINITURE TASTIERE

TAPS
FINISHES
CONTROLS

Rubinetteria per vasche

Taps for tubs

Forme cilindriche o squadrate. Le due linee di rubinetteria coordinata esprimono con un design moderno e raffinato due diversi concetti estetici, due scuole di pensiero per interpretare la vasca con il proprio gusto, a quattro o tre fori.

Cylindrical or square shapes. According with their modern and sophisticated design, with four or three holes, they express two different aesthetical concepts, two schools of thought to interpret the tub with a proper own taste.



nuovo sistema antigoccia
(esclusa linea Bolla)
new drip-proof system
(Bolla line excluded)

Modelli _ Bolla Sfiato - Bolla con E.T.P.

Models_ Bolla Sfiato - Bolla with water filling from overflow



LOFT A1

Mix due fori
con E.T.P.

*Mix two holes
with water filling
from overflow*



LOFT A2

Mix quattro fori
con E.T.P.

*Mix four holes
with water filling
from overflow*



PRESTIGE A1

Mix tre fori
con E.T.P.

*Mix three holes
with water filling
from overflow*



PRESTIGE A2

Mix quattro fori
con E.T.P.

*Mix four holes
with water filling
from overflow*



**PIANTANA
Pedestal**

Modelli _ Bolla Ø 160, Bolla R 162x112, Bolla Q 160

Models_ Bolla Ø 160, Bolla R 162x112, Bolla Q 160



LOFT B1

Mix due fori +
bocca di erogazione

*Mix two holes
+ water spout*



LOFT B2

Mix tre fori +
bocca di erogazione

*Mix three holes
+ water spout*



PRESTIGE B1

Mix due fori +
bocca di erogazione

*Mix two holes
+ water spout*



PRESTIGE B2

Mix tre fori +
bocca di erogazione

*Mix three holes
+ water spout*

Rubinetteria Taps

Modello _ Nova
Model _ Nova



REAL mod. E
Mix tre fori
+ E.T.P.
*Mix three holes
+ water filling from
overflow*



REAL mod. F
Mix tre fori +
bocca di erogazione
*Mix three holes
+ water spout*

Modelli _ Sensual
Models _ Sensual



LOFT B1
Mix tre fori +
bocca di erogazione
*Mix three holes
+ water spout*



LOFT B2
Mix quattro fori +
bocca di erogazione
*Mix four holes
+ water spout*

Modello: Move.
Model: Move.



PIANTANA QUADRA
Con bocca
di erogazione
*Square pedestal
with water spout*



PIANTANA TONDA
Con bocca
di erogazione
*Round pedestal
with water spout*

Rubinetteria QUADRA Square taps

Modelli: Mode, Era.
Models: Mode, Era.



LOFT A1
Mix tre fori
con E.T.P.
*Mix three holes
with water filling
from overflow*



LOFT A2
Mix quattro fori
con E.T.P.
*Mix four holes
with water filling
from overflow*



LOFT B1
Mix tre fori +
bocca di erogazione
a cascata
*Mix three holes
+ water spout
with water cascade*



LOFT B2
Mix quattro fori +
bocca di erogazione
a cascata
*Mix three holes
+ water spout
with water cascade*

Rubinetteria TONDA Round taps

Modelli: Zaphiro, Oasy, Eva, Ondaria, Gamma, Igloo, Ego, Diva.
Models: Zaphiro, Oasy, Eva, Ondaria, Gamma, Igloo, Ego, Diva.



PRESTIGE A1
Mix tre fori
con E.T.P.
*Mix three holes
with water filling
from overflow*



PRESTIGE A2
Mix quattro fori
con E.T.P.
*Mix four holes
with water filling
from overflow*



PRESTIGE B1
Mix tre fori +
bocca di erogazione
*Mix three holes
+ water spout*



PRESTIGE B2
Mix quattro fori +
bocca di erogazione
*Mix four holes
+ water spout*

Modello: Calle, Rio.
Model: Calle, Rio.



PRESTIGE B1
Mix tre fori +
bocca di erogazione
*Mix three holes
+ water spout*



PRESTIGE B2
Mix quattro fori +
bocca di erogazione
*Mix four holes
+ water spout*

Modello: Duo.
Model: Duo.



PRESTIGE A1
Mix tre fori
+ E.T.P.
*Mix three holes
+ water filling from
overflow*



PRESTIGE B1
Mix tre fori +
bocca di erogazione
*Mix three holes
+ water spout*



PRESTIGE A2
Mix quattro fori
+ E.T.P.
*Mix four holes
+ water filling from
overflow*



PRESTIGE B2
Mix quattro fori +
bocca di erogazione
*Mix four holes
+ water spout*



Miscelatore
termostatico a 1 + 5 vie
*1+5 ways
thermostatic mixer*

Finiture vasche Hafro

Tubs Hafro finishes

PANNELLI FENIX _ Modelli: Bolla 190 Q, Bolla 200 R.
Fenix panels _ Models: Bolla 190, Bolla 200 R.



Grigio Efeso Grigio Bromo Grigio Londra

Finitura Fenix coordinata con i prodotti Saunavita (OLIMPO - ETHOS C - ETHOS L - GHIBLI SAUNA)
Fenix finishes matching with Saunavita products (OLIMPO - ETHOS C - ETHOS L - GHIBLI SAUNA)

PANNELLI SOLID SURFACE _ Modello: Bolla Q, Bolla R.
Solid Surface panels _ Model: Bolla Q, Bolla R.



Bianco

PANNELLI ACRILICO _ Modelli: Nova, Era (esclusa 200x120), Eva, Duo, Ondaria, Gamma, Igloo, Ego Diva, Zaphiro.
Acrylic panels _ Model: Nova, Era (excluded 200x120), Eva, Duo, Ondaria, Gamma, Igloo, Ego Diva, Zaphiro.



Bianco

PANNELLI RIVESTITI IN ACRILICO _ Modelli: Mode
Acrylic coated panels _ Model: Mode.



Bianco

**PANNELLI RIVESTIBILI
IN MOSAICO O PIASTRELLE**
Dressable panels with mosaic or tiles

La pannellatura è predisposta per essere rivestita con mosaico o piastrelle, proseguendo così la finitura delle pareti con un suggestivo effetto di continuità. Modelli Eva/Linea Era (esclusa 180x120/70).

The panelling is arranged to be covered with mosaic or tiles, the same of the finishing of the walls with a suggestive effect of continuity. Modelli Eva/Linea Era (excluded 180x120/70).



Vasche coordinate con l'arredo bagno Geromin

Bathtubs matching the Geromin bathroom furnitures

PANNELLI LACCATI LUCIDI E OPACHI _ Modelli: Rio, Sensual, Mode, Minerva, For All, Era, Eva.
Glossy and matt lacquered panels _ Models: Rio, Sensual, Mode, Minerva, For All, Era, Eva.



Bianco Bianco Perla Grigio Chiaro Ghiaccio Grigio Cenere Grigio Medio Grigio Tortora Grigio Efeso



Grigio Fumo Grigio Scuro Grigio Bromo Nero Brown Grigio Londra Grigio Cosmico Cashmere



Bianco Panna Beige Scuro Marrone Marsala Toffee Miele Aragosta Arancio



Giallo Ocra Rosso Ciliegia Corallo Cipria Cielo Blu Cobalto



Oceano Petrolio Salvia Timo Menta Cactus Verde Oliva Verde Pistacchio

VASCHE IN TECNOTEK

Tecnotek tubs

Modelli: Rio, Calle.
Models: Rio, Calle.

Modello: Move.
Model: Move.

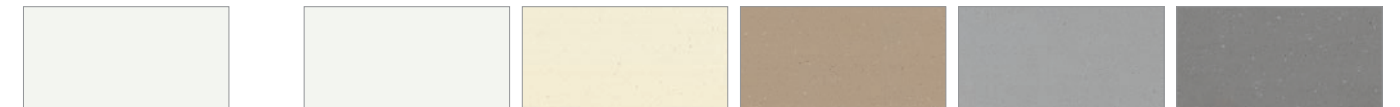

Bianco Bianco Crema Terra Grigio Chiaro Grigio Scuro

PANNELLI ECOMALTA _ Modelli: Minerva, Bolla 190Ø.
Ecomalta panels _ Models: Minerva, Bolla 190Ø.



Bianco Terra Grigio chiaro Grigio scuro

Tastiere per vasche

Controls for tubs



TASTIERA DIGITALE _ Modello: Rio.
Digital keypad _ Model: Rio.



TASTIERA DIGITALE _ Modelli: Calle, Sensual.
Digital keypad _ Models: Calle, Sensual.

Comandi di accensione e di regolazione dell'idromassaggio airpool integrati nella vasca.
The commands to turn on and regulate the airpool hydromassage are integrated into the tub.

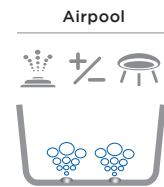

TASTIERA DIGITALE SENZA RICIRCOLO DELL'ACQUA _ Modello: Bolla.
Digital keypad without water purification system _ Model: Bolla.

Le funzioni di idromassaggio della versione senza ricircolo d'acqua si attivano direttamente dalla vasca.
The hydromassage functions, on versions without water purification systems, can be directly activated from the tub itself.

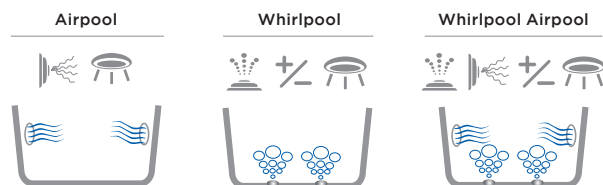

TASTIERA DIGITALE CON RICIRCOLO DELL'ACQUA _ Modello: Bolla.
Digital keypad with water purification system _ Model: Bolla.

Dopo l'accensione con il tasto installato nella vasca, tutte le funzioni si controllano comodamente mediante un telecomando.
Switch on pressing key built in the tub: every function can be easily controlled using hi-tech remote control.

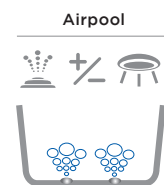

TASTIERA TOUCH _ Modello: Minerva.
Digital keypad _ Model: Minerva.

Sistema whirlpool airpool con ricircolo automatico dell'acqua
Whirlpool airpool with water recirculation system

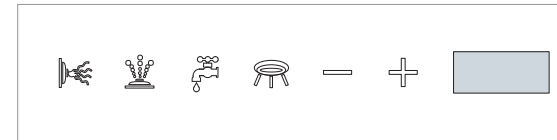

Audio-musica per sistema whirlpool airpool (optional)
Audio system with whirlpool airpool system (optional)

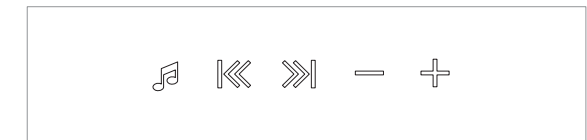

TASTIERA DIGITALE _ Modelli: Minerva, Era, Eva, Zaphiro, Oasy, Mode, Duo, Ondaria, Gamma, Igloo, Ego, Diva.
Digital keypad _ Models: Minerva, Era, Eva, Zaphiro, Oasy, Mode, Duo, Ondaria, Gamma, Igloo, Ego, Diva.

Airpool



Whirlpool



Whirlpool Airpool



Professional Whirlpool Airpool



Vasca con Microsilk / Tub with Microsilk



COMANDO MANUALE

Mechanic control

Il comando manuale segue il design delle rubinetterie nella versione cilindrica e quadrata per un perfetto coordinamento.
The manual command follows the design of the faucet in the cylindrical and square version for a perfect coordination.



PRESTIGE
Whirlpool on-off con regolazione aria
Whirlpool on-off con regolazione aria



LOFT
Whirlpool on-off con regolazione aria
Whirlpool on-off con regolazione aria

COMANDO DIGITALE _ Modello: Nova.
Digital control _ Model: Nova.

Comando digitale Airpool e whirlpool.
Airpool and whirlpool digital comand.



Airpool



Whirlpool



Whirlpool Airpool

VASCHE AD INCASSO

BUILT-IN BATHTUBS

Bolla ⁴¹⁰

Zaphiro ⁴¹⁰

Oasy ⁴¹⁰

Era Plus ⁴¹¹

Era ⁴¹¹

Mode ⁴¹²

Eva ⁴¹²

Duo ⁴¹²

Ondaria ⁴¹³

Gamma ⁴¹³

Igloo ⁴¹³

Ego ⁴¹³

Diva ⁴¹³

Nova ⁴¹⁴

Nova Plus ⁴¹⁵

HAFRO
acqua, per piacere

Bolla Q 160x160



Zaphiro 200x100



Bolla 160



Oasy 195x115



Bolla R 162x112



Era Plus 180x120/70 dx rh



Era Plus 180x120/70 sx lh



Era Plus 200x120



Era Plus 190x90



Era Plus 180x80



Era Plus 140x140



Era 170x75



Era 170x70



Mode 190x80 dx-sx *rh-lh*Mode 180x90 dx-sx *rh-lh*

Mode 180x75

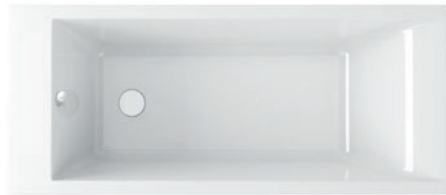
Mode 170x80 dx-sx *rh-lh*Mode 160x90/70 dx *rh*Mode 160x90/70 sx *lh*

Eva 180x80



Eva 170x70



Duo 170x65/78



Ondaria 180x80



Ondaria 170x75



Ondaria 170x70

Gamma 170x70/76 dx *rh*Gamma 170x70/76 sx *lh*

Igloo 160x160



Ego 150x150



Diva 140x140



Nova 180x80



Nova 150x70



Nova 160x100 dx-sx rh-lh



Nova Plus 140x140



Nova 170x80



Nova 140x70



Nova 140x140



Nova 170x70



Nova 130x70



Nova 170x65



Nova 120x70



Nova 120x120



Nova 160x70



Nova 110x70



Nova 160x65



Si ringrazia Hotel Le Palme (NO-Italia) per le immagini di pagina 16 e 173. Progetto di Desark Contract Sa.

Le immagini stampate non riproducono perfettamente i colori e i toni dei nostri modelli. L'azienda si riserva di apportare tutte le modifiche ritenute necessarie al continuo miglioramento e rinnovamento dei modelli.

Thanks to Hotel Le Palme (NO-Italy) for the images on page 16 and 173. Project by Desark Contract Sa.

The printed images do not reproduce perfectly the colours and shades of our models. The company reserves the rights to make all modification necessary for the improvement and renewal of the model.



VENEZIA 1945



GRUPPO GEROMIN Srl

Via 1° Maggio, 5 - 30029 San Stino di Livenza VE-I
TEL +39 0421 312 249 - 312 250 FAX +39 0421 312 257
info@gruppogeromin.com